

KS

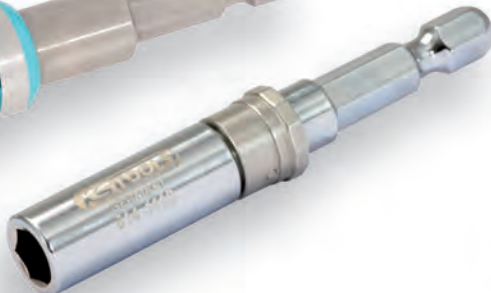

KS TOOLS

BITS



Innovation is
our mission!

	PAGE
BIT HOLDERS	186
ADAPTOR	186 - 187
SCREWDRIVER BITS	187
RATCHET BIT SCREWDRIVER	188
BIT RATCHETS	188 - 189
1/4" SCREWDRIVING TOOLS	189
MICRO BITS	189 - 190
1/4" CLASSIC BITS 25 mm	190 - 193
1/4" CLASSIC BIT SETS 25 mm	193 - 197
1/4" CLASSIC BITS 50 mm	198 - 199
1/4" CLASSIC BITS 75 mm	199 - 201
1/4" CLASSIC BIT SETS 75 mm	201
1/4" TIN BITS 25 mm	202
1/4" TIN BITS 50 mm	202 - 203
1/4" TORSION ^{power} BITS 25 mm	203
1/4" TORSION ^{power} BITS 75 mm	204
1/4" TORSION ^{power} BIT SETS	205
5/16" CLASSIC BITS	205 - 206
5/16" CLASSIC BIT SETS	206
10 mm CLASSIC BITS 30 mm	206 - 207
10 mm CLASSIC BITS 75 mm	207
10 mm CLASSIC BITS 120 mm	207
10 mm CLASSIC BIT SETS	207 - 208

BITS Composition

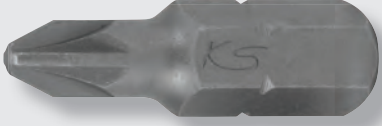
- Cold formed
- S2 special steel for optimal hardness and elasticity
- Good torque transmission
- Optimal positive seating in DIN screws
- Grooved for fixing into a holder
- Suited for all screw applications for manual and machine usage
- Precision finished according to DIN/ISO



- With torsion zone
- To cushion high level torque
- Longer service life
- Turned and precision milled
- S2 special steel for optimal hardness and elasticity
- Highest torque transmission
- Optimal positive seating in DIN screws
- With colour coding for quick identification of the suitable profile
- Grooved for fixing into a holder
- Suited for all screw applications for manual and machine usage
- Precision finished according to DIN/ISO



- Good torque transmission
- Especially for constant load during industrial applications
- Cold formed
- S2 special steel for optimal hardness and elasticity
- Optimal positive seating in DIN screws
- Grooved for fixing into a holder
- Suited for all screw applications for manual and machine usage
- Precision finished according to DIN/ISO

Surfaces

Phosphate



- Phosphating = chemical /electro-chemical process
- Dip coating or spraying method
- Intention is the generation of phosphate layer, which is immovable on the base metal
- The surface receives therefore a very good absorption capacity for oil and wax
- Reliable corrosion protection
- To be bound to phosphated tools when oiled

Nickel plated



- The chrome layer is manufactured by electroplating in a electro bath process
- There are several steps that are passed through
- Nickel offers a very good corrosion protection and is resistant against air, water, diluted acids and most treatments of alkaline solution.
- The light gold optics are typical

TiN coated

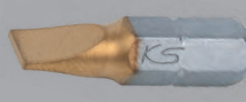

- A titanium nitride coating is applied to the tough steel core
- There are several steps that are passed through
- For heavy loading in permanent use
- The gold optics are typical

Bit case

- Quick and direct bit adaptor
- Practical pocket sized
- With switchable, fine-toothed ratchet mechanism
- Ideal for work on assembly lines and frameworks
- Spring loaded design



CLOCKWISE FASTENING ✓ COUNTER CLOCKWISE FASTENING

Bit profile

MICRO

- Surface nickel-plated
- Manufactured from S2 special steel
- Cold formed
- Extra short execution
- Precision finished according to DIN/ISO

CLASSIC

- Surface sand-blasted, phosphate or nickel plated
- Manufactured from S2 special steel
- Cold formed
- Precision finished according to DIN/ISO

TORION *power*

- Surface nickel-plated
- Turned and precision milled
- Manufactured from S2 special steel
- Precision finished according to DIN/ISO

TINBits

- Titanium nitride coated
- Turned and precision milled
- Manufactured from S2 special steel
- Precision finished according to DIN/ISO

Bits that are too hard break, those that are too soft wear out.

The screw and the bit must be compatible. If this is not the case, even the best bit or screw is ruined.

This basic rule is unfortunately neglected time and again by many tradesmen.

The increase in variety of screw types does not make it easy.

Therefore you can find a comprehensive range of bits and bit holders on the following pages.

For all areas of application:

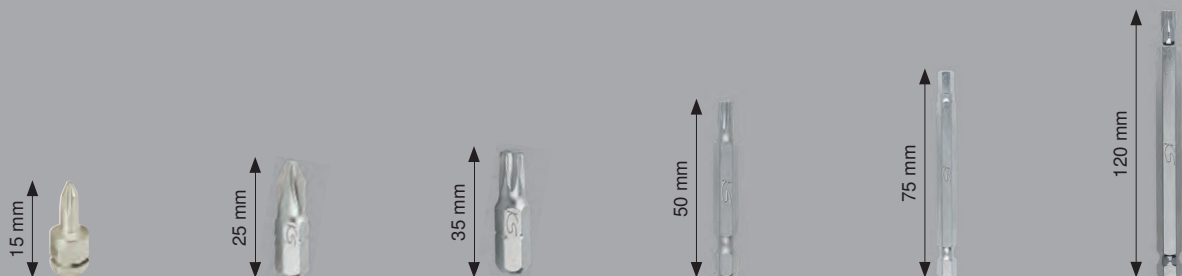

Drive profile

1/4"

5/16"

10 mm



BIT HOLDERS

Magnetic bit holder

- DIN 7427
- Magnetic
- For 1/4" Bits with external hexagon drive to DIN 3126 / ISO 1173 - C 6,3
- Can be used by hand, electric screwdriver and drills
- Ideally suited for fittings in trade and industry
- Special steel

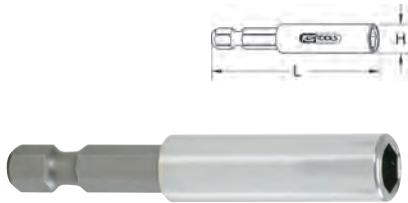

	●	○	H mm	L mm	⚖
514.1102	1/4"	1/4"	10.0	50.0	50
514.1103	1/4"	1/4"	10.0	100.0	60

Magnetic bit holder with depth adjustment

- Ideally suited for working in dry lining
- Magnetic
- Depth adjustment
- For 1/4" Bits with external hexagon drive to DIN 3126 / ISO 1173 - C 6,3
- Can be used by hand, electric screwdriver and drills
- Ideally suited for fittings in trade and industry
- Special steel



	●	○	H mm	L mm	⚖
514.1109	1/4"	1/4"	15.0	57-63	20

Magnetic quick release bit holder

- Magnetic
- Quick change function and locking device
- For 1/4" Bits with external hexagon drive to DIN 3126 / ISO 1173 - C 6,3
- Can be used by hand, electric screwdriver and drills
- Ideally suited for fittings in trade and industry
- Special steel



	●	○	H mm	L mm	⚖
514.1104	1/4"	1/4"	15.0	50.0	50
514.1110	1/4"	1/4"	15.0	150.0	130
514.1111	1/4"	1/4"	15.0	305.0	250

Magnetic quick release bit holder

- Magnetic
- Quick change function and locking device
- For 1/4" Bits with external hexagon drive to DIN 3126 / ISO 1173 - C 6,3
- Can be used by hand, electric screwdriver and drills
- Ideally suited for fittings in trade and industry
- Special steel

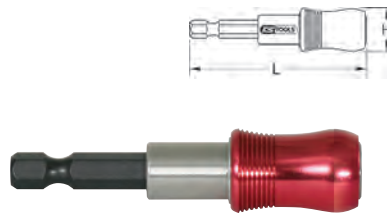

	●	○	H mm	L mm	⚖
514.1114	1/4"	1/4"	16.0	65.0	50

STAINLESS STEEL quick release bit holder

- With quick change function and locking device
- For 1/4" Bits with external hexagon drive to DIN 3126 / ISO 1173 - C 6,3
- Can be used by hand, electric screwdriver and drills
- Ideally suited for fittings in trade and industry
- Suitable for use at extremely low temperatures
- Extreme resistance to intergranular corrosion and oxidation
- Extremely long service life
- Autoclavable (heating of the tools to over 100°C to kill germs)
- Rust-proof and acid resistant
- Stainless steel



	●	○	H mm	L mm	⚖
910.1114	1/4"	1/4"	16.0	65.0	50

Auto slimlock magnetic quick release bit holder

- Extremely slim design - ideal for hard to access areas
- Magnetic
- Quick change function and locking device
- For 1/4" Bits with external hexagon drive to DIN 3126 / ISO 1173 - C 6,3
- Can be used by hand, electric screwdriver and drills
- Ideally suited for fittings in trade and industry
- Special steel



	●	○	H mm	L mm	⚖
514.1113	1/4"	1/4"	11.5	68.0	30

ADAPTOR

Square drive adaptor

- External hexagon drive
- 1/4" square drive adaptor to DIN 3120 / ISO 1174 with ball lock
- Ideally suited for fittings in trade and industry
- Chrome plated
- Special steel



	●	■	L mm	⚖
503.8232	5/16"	1/4"	21.0	8
503.8233	10,0	1/4"	24.5	10

Square drive adaptor

- External hexagon drive to DIN 3126 / ISO 1173 - C 6,3
- Square drive adaptor to DIN 3120 / ISO 1174 with ball lock
- Ideally suited for fittings in trade and industry
- For using in electric drivers and drills
- Sand blasted
- Special steel

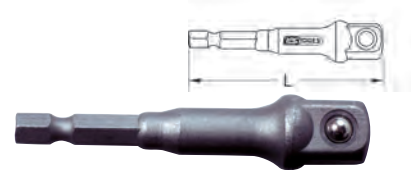

	■	●	L mm	⚖
514.1106	1/4"	1/4"	65.0	20
514.1107	3/8"	1/4"	65.0	30
514.1108	1/2"	1/4"	70.0	40

Socket drive adaptor set

- External hexagon drive to DIN 3126 / ISO 1173
- Square drive adaptor to DIN 3120 / ISO 1174 with ball lock
- Ideally suited for fittings in trade and industry
- For using in electric drivers and drills
- Sand blasted
- Special steel



		⚖
514.1105	3 pcs 1/4" - 3/8" - 1/2"	100

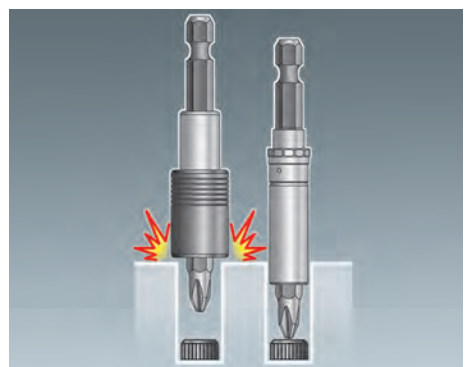

Magnetic SDS bit holder

- SDS adaptor
- Magnetic
- For 1/4" Bits with external hexagon drive to DIN 3126 / ISO 1173 - C 6,3
- Ideally suited for fittings in trade and industry
- For using in electric drivers and drills with SDS adaptor
- Special steel



	⊙	H mm	L mm	g
514.1130	1/4"	11.0	75.0	35



Magnetic SDS quick release bit holder

- SDS adaptor
- Magnetic
- Quick change function and locking device
- For 1/4" Bits with external hexagon drive to DIN 3126 / ISO 1173 - C 6,3
- Ideally suited for fittings in trade and industry
- For using in electric drivers and drills with SDS adaptor
- Special steel



	⊙	H mm	L mm	g
514.1131	1/4"	14.0	78.0	40

SDS socket drive adaptor

- SDS adaptor
- Square drive adaptor to DIN 3120 / ISO 1174 with ball lock
- Ideally suited for fittings in trade and industry
- For using in electric drivers and drills with SDS adaptor
- Sand blasted
- Special steel

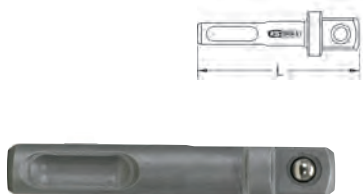

	■	L mm	g
514.1132	3/8"	60.0	20
514.1133	1/2"	65.0	50



SDS chuck adaptor

- SDS adaptor
- Thread 1/2" x 20 Pitch
- Ideally suited for fittings in trade and industry
- For using in electric drivers and drills with SDS adaptor
- Special steel



	H mm	L mm	g
514.1134	18.0	65.0	40

SCREWDRIVER BITS

ERGOTORQUE® bit screwdriver

- Extra short execution
- Magnetic
- One component handle
- Optimal power transmission
- 1/4" hexagonal holder for bits
- Hanging hole



	⊙	L mm	g
911.1190	1/4"	63.0	30

ERGOTORQUE® bit screwdriver

- One component handle
- Optimal power transmission
- Magnetic
- For bits to DIN 3126 / C 6,3
- Hanging hole
- Blade made of chrome vanadium



	⊙	L1 mm	L2 mm	L3 mm	g
911.1198	1/4"	200.0	100.0	100.0	90
911.1199	1/4"	250.0	150.0	100.0	100

ERGOTORQUE® quick change bit screwdriver

- Locking and fast change device
- One component handle
- Optimal power transmission
- Magnetic
- For bits to DIN 3126 / C 6,3
- Hanging hole
- Blade made of chrome vanadium



	⊙	L1 mm	L2 mm	L3 mm	g
911.1145	1/4"	200.0	100.0	100.0	100

ERGOTORQUE® bit screwdriver

- Flexible
- Limited torque
- Double spiral shaft
- One component handle
- Plastic protective coating
- 1/4" hexagonal holder for bits
- Hanging hole



	⊙	L1 mm	L2 mm	L3 mm	L4 mm	g
911.1129	1/4"	200.0	150.0	50.0	8.0	200

ERGOTORQUEplus® bit screwdriver, extra long

- Flexible blade with double spiral shaft
- Limited torque
- For bits to DIN 3126 / C 6,3
- Plastic protective coating
- Two component handle
- Hanging hole



	⊙	L1 mm	L2 mm	L3 mm	L4 mm	g
911.1172	1/4"	614.0	500.0	114.0	43.0	280

ERGOTORQUEplus® bit screwdriver

- Two component handle
- Optimal power transmission
- Magnetic
- For bits to DIN 3126 / C 6,3
- Hanging hole
- Blade made of chrome vanadium



	⊙	L1 mm	L2 mm	L3 mm	g
159.1198	1/4"	205.0	100.0	105.0	90

RATCHET BIT SCREWDRIVER

Ratchet bit screwdriver

- Robust gearing with 24 teeth
- Ratchet function
- 180° multi adjustable blade
- For bits to DIN 3126 / C 6,3
- Magnetic
- Integrated bit magazine with 13 bits
- Ergonomically designed handle

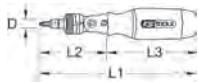

	1/4"	D mm	L1 mm	L2 mm	L3 mm	g
911.2470	1/4"	10.0	190.0	82.0	108.0	380

T-handle ratchet bit screwdriver

- Robust gearing with 24 teeth
- Ratchet function
- Locking and fast change device
- 45° two way revolving head
- For bits to DIN 3126 / C 6,3
- Fast change bit stop function
- Magnetic
- Integrated bit magazine with 5 bits
- Two component handle

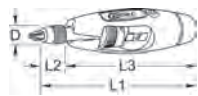

	1/4"	D mm	L1 mm	L2 mm	L3 mm	g
911.2475	1/4"	15.0	140.0	26.0	114.0	380



Mini ratchet screwdriver

- Exact gearing with 72 teeth
- Ratchet function
- For bits to DIN 3126 / C 6,3
- Magnetic
- Two component handle
- Blade mirror polished chrome



	1/4"	L1 mm	L2 mm	L3 mm	g
159.2061	1/4"	95.0	27.0	68.0	140

Revolver ratchet bit screwdriver

- Exact gearing with 72 teeth
- Ratchet function
- Handle with double function (standard and pistol handle)
- For bits to DIN 3126 / C 3,6
- Magnetic
- 40 Nm maximum torque
- Integrated bit magazine
- Two component handle
- Blade mirror polished chrome



	1/4"	L1 mm	L2 mm	L3 mm	g
159.2051	1/4"	260.0	130.0	130.0	450



BIT RATCHETS

Bit ratchet reversible with adaptor for sockets

- With 1/4" square drive adaptor to DIN 3120 / ISO 1174 with ball lock
- For bits with external hexagon drive to DIN 3126 / ISO 1173 - C 6,3
- Switchable
- Gearing with 72-teeth
- Extremely flat construction form
- Matt finished chrome
- Special steel



	L mm	D mm	1/4"	1/4"	g
918.1595	2 pcs	100.0	1/4"	1/4"	170

CHROMEplus® bit reversing ratchet

- For bits with external hexagon drive to DIN 3126 / ISO 1173 - C 6,3
- Reversible
- Gearing with 72 teeth
- Two component handle
- Chrome plated and mirror polished
- Special steel



	A mm	D mm	L mm	Repair set	g
918.1495	18.5	22.0	115.0	914.1494	160

Bit reversing ratchet

- For bits with 10 mm external hexagon drive
- Reversible
- Gearing with 72 teeth
- Two component handle
- Mirror polished
- Special steel



	A mm	D mm	L mm	Repair set	g
914.3893	30.0	32.0	120.0	914.3494	180

GEARplus® mini reversible ratcheting spanner

- Especially handy and compact
- Rotating assembly
- One way angled head
- Exact gearing with 72 teeth
- Chrome plated and mirror polished
- Chrome vanadium



	A1 mm	A2 mm	B1 mm	B2 mm	L mm	g	
503.4691	1/4" x 1/4"	9.7	7.8	12.6	14.2	90.0	40

GEARplus® Double ratchet ring spanner

- FlankTraction profile (12 point)
- In accordance to DIN 3110 / ISO 3318
- Straight form
- Exact gearing with 72 teeth
- Chrome plated and mirror polished
- Chrome vanadium

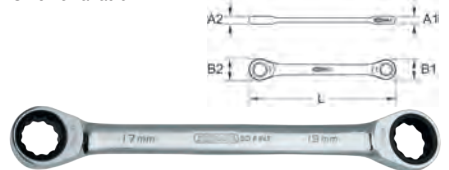

	A1 mm	A2 mm	B1 mm	B2 mm	L mm	g	
503.4511	8x10	7.3	6.5	20.0	17.0	128.0	40

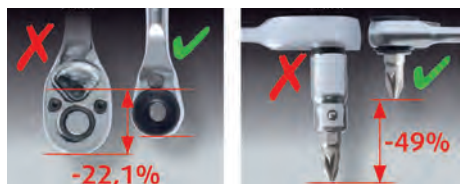

GEARplus® mini reversible ratcheting spanner

- Especially handy and compact
- Rotating assembly
- One way angled head
- Exact gearing with 72 teeth
- Chrome plated and mirror polished
- Chrome vanadium



	○	A1 mm	A2 mm	B1 mm	B2 mm	L mm	⚖
503.4678	1/4" x 10mm	13.5	9.7	19.3	14.2	124.5	40
503.4679	1/4" x 5/16"	10.2	9.7	17.2	14.2	115.0	40

1/4" SCREWDRIVING TOOLS

CLASSIC drive socket, magnetic

- Magnetic
- External hexagon drive to DIN 3126 / ISO 1173 - C 6,3
- Can be used by hand or with and electric screwdriver
- For a damage free inserting boring and unscrewing bolts
- Ideally suited for fittings in trade and industry
- Sand blasted
- Special steel



	⚖	mm	L mm	H mm	⚖
122.2171	5,0	60,0	11,0	25	
122.2172	6,0	60,0	11,0	25	
122.2101	7,0	60,0	11,0	30	
122.2102	8,0	60,0	12,0	30	
122.2103	10,0	60,0	15,0	40	
122.2173	12,0	60,0	18,0	48	
122.2104	13,0	60,0	18,0	50	

CLASSIC stud screwdriver

- External hexagon drive to DIN 3126 / ISO 1173 - C 6,3
- Can be used by hand or with and electric screwdriver
- For a damage free inserting boring and unscrewing bolts from floor
- Ideally suited for fittings in trade and industry
- Sand blasted
- Special steel



		L mm	H mm	⚖
122.2105	M6	50,0	12,0	20
122.2106	M8	50,0	12,0	20
122.2107	M10	50,0	12,0	20
122.2108	M12	50,0	14,0	20

CLASSIC bit and drive socket set

- Ideal set of compilation for plumbing heating and air conditioning
- External hexagon drive to DIN 3126 / ISO 1173 - C 6,3
- Can be used by hand or with and electric screwdriver
- Ideally suited for fittings in trade and industry
- Includes magnetic drive sockets and stud screwdrivers for a damage free inserting boring and unscrewing bolts and stud bolts
- Orderly arrangement of the popular 1/4" bits and drive sockets
- Sand blasted
- Special steel
- In durable plastic storage case



	⚖			⚖
122.2100	31 pcs	CLASSIC bit and drive socket set		0,67
4 x		7 - 8 - 10 - 13 mm		
4 x		M6 - M8 - M10 - M12		
1 x		50 mm		
5 x		PH1 - 3 x PH2 - PH3		
5 x		PZ1 - 3 x PZ2 - PZ3		
2 x		5,5 - 6,5 mm		
3 x		4 - 5 - 6 mm		
7 x		T10 - T15 - T20 - T25 - T27 - T30 - T40		

CLASSIC bit and drive socket display

- Ideal set of compilation for plumbing heating and air conditioning
- External hexagon drive to DIN 3126 / ISO 1173 - C 6,3
- Can be used by hand or with and electric screwdriver
- Ideally suited for fittings in trade and industry
- Includes magnetic drive sockets and stud screwdrivers for a damage free inserting boring and unscrewing bolts and stud bolts
- Orderly arrangement of the popular 1/4" bits and drive sockets
- Special steel
- Supplied in counter sales display



	⚖			⚖
122.2100D	10 pcs	10 x 122.2100		7,00

MICRO BITS

Micro bit for slotted screws

- Slotted
- External hexagon drive and locking ring
- For hand usage with a GEARplus spanner 503.4511
- Ideally suited for fittings in trade and industry
- Nickel plated
- Special steel



	mm	○	L mm	Content	⚖
503.8221	4,0	8,0	15,0	1	10

Micro bit for hexagon screws

- Hexagon socket
- External hexagon drive and locking ring
- For hand usage with a GEARplus spanner 503.4511
- Ideally suited for fittings in trade and industry
- Nickel plated
- Special steel



	mm	○	L mm	Content	⚖
503.8131	4,0	8,0	15,0	1	10
503.8132	5,0	8,0	15,0	1	10
503.8133	6,0	10,0	15,0	1	10
503.8134	7,0	10,0	15,0	1	10
503.8135	8,0	10,0	15,0	1	10

Micro bit for phillips screws PH

- PH
- External hexagon drive and locking ring
- For hand usage with a GEARplus spanner 503.4511
- Ideally suited for fittings in trade and industry
- Nickel plated
- Special steel



	○	L mm	Content	⚖
503.8101	PH0	8,0	20,0	1 10
503.8102	PH1	8,0	20,0	1 10
503.8103	PH2	8,0	20,0	1 10

Micro bit for spline screws

- Spline
- External hexagon drive and locking ring
- For hand usage with a GEARplus spanner 503.4511
- Ideally suited for fittings in trade and industry
- Nickel plated
- Special steel

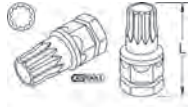

	Ø	L mm	Content	1	10
503.8152	M5	8,0	23,0	1	10
503.8153	M6	10,0	23,0	1	10
503.8154	M8	10,0	23,0	1	10
503.8155	M10	10,0	23,0	1	10

TORX® MICRO bits

- TX
- External hexagon drive and locking ring
- For hand usage with a GEARplus spanner 503.4511
- Ideally suited for fittings in trade and industry
- Nickel plated
- Special steel



	Ø	L mm	Content	1	10
503.8170	T8	8,0	23,0	1	10
503.8171	T10	8,0	23,0	1	10
503.8172	T15	8,0	23,0	1	10
503.8173	T20	8,0	23,0	1	10
503.8174	T25	8,0	23,0	1	10
503.8175	T27	8,0	23,0	1	10
503.8176	T30	8,0	23,0	1	10
503.8177	T40	10,0	23,0	1	10
503.8178	T45	10,0	23,0	1	10



TORX® MICRO bits, tamper proof

- For tamperproof TX
- External hexagon drive and locking ring
- For hand usage with a GEARplus spanner 503.4511
- Ideally suited for fittings in trade and industry
- Nickel plated
- Special steel



	Ø	L mm	Content	1	10
503.8200	TB8	8,0	23,0	1	10
503.8201	TB10	8,0	23,0	1	10
503.8202	TB15	8,0	23,0	1	10
503.8203	TB20	8,0	23,0	1	10
503.8204	TB25	8,0	23,0	1	10
503.8205	TB27	8,0	23,0	1	10
503.8206	TB30	8,0	23,0	1	10
503.8207	TB40	10,0	23,0	1	10
503.8208	TB45	10,0	23,0	1	10

Micro bit set

- External hexagon drive and locking ring
- For manual operation
- Includes reversing GEARplus® bit ratchet ring spanner
- Ideally suited for fittings in trade and industry
- Precise and orderly arrangement of the popular micro-bits
- Nickel plated
- Special steel



	Content	1	520
503.4670	32 pcs Micro bit set		520
1 x	8 x 10 mm		
1 x	4 mm		
3 x	PH0 - PH1 - PH2		
5 x	4 - 5 - 6 - 7 - 8 mm		
4 x	5 - 6 - 8 - 10 mm		
9 x	T8 - T10 - T15 - T20 - T25 - T27 - T30 T40 - T45		
9 x	TB8 - TB10 - TB15 - TB20 - TB25 TB27 - TB30 - TB40 - TB45		

1/4" CLASSIC BITS 25 mm

CLASSIC bit for slotted screws

- Slotted
- External hexagon drive to DIN 3126 / ISO 1173 - C 6,3
- Can be used by hand or with an electric screwdriver
- Ideally suited for fittings in trade and industry
- Nickel plated
- Special steel



	mm	L mm	Content	1	10
911.3303	3,0	25,0	1	6	
911.3304	3,0	25,0	5	40	
911.3305	3,5	25,0	1	6	
911.3306	3,5	25,0	5	40	
911.2237	4,0	25,0	1	6	
911.2238	4,0	25,0	5	40	
911.2240	4,5	25,0	1	6	
911.2241	4,5	25,0	5	40	
911.2392	5,0	25,0	1	5	
911.2492	5,0	25,0	5	40	
911.2243	5,5	25,0	1	6	
911.2244	5,5	25,0	5	40	
911.2246	6,0	25,0	1	6	
911.2247	6,0	25,0	5	40	
911.2249	6,5	25,0	1	8	
911.2250	6,5	25,0	5	50	
911.3307	7,0	25,0	1	8	
911.3308	7,0	25,0	5	50	
911.2252	8,0	25,0	1	8	
911.2253	8,0	25,0	5	50	
911.3309	9,0	25,0	1	8	
911.3310	9,0	25,0	5	50	
911.3311	10,0	25,0	1	8	
911.3312	10,0	25,0	5	50	
911.3313	11,0	25,0	1	8	
911.3314	11,0	25,0	5	50	



CLASSIC bit for hexagon screws

- Hexagon socket
- With external hexagon drive to DIN 3126 / ISO 1173 - C 6,3
- Can be used by hand or with an electric screwdriver
- Ideally suited for fittings in trade and industry
- Nickel plated
- Special steel



1/4"

	mm	L mm	Content	
911.3558	1,5	25,0	1	6
911.3559	1,5	25,0	5	40
911.2377	2	25,0	1	5
911.3561	2	25,0	5	40
911.2386	2,5	25,0	1	5
911.3563	2,5	25,0	5	40
911.2255	3	25,0	1	6
911.2256	3	25,0	5	40
911.2258	4	25,0	1	6
911.2259	4	25,0	5	40
911.2261	5	25,0	1	6
911.2262	5	25,0	5	40
911.2264	6	25,0	1	6
911.2265	6	25,0	5	40
911.2267	7	25,0	1	8
911.2268	7	25,0	5	50
911.2270	8	25,0	1	8
911.2271	8	25,0	5	50
911.2399	10	25,0	1	10
911.3565	10	25,0	5	50
911.3566	1/16"	25,0	1	6
911.3611	1/16"	25,0	5	40
911.3567	5/64"	25,0	1	6
911.3612	5/64"	25,0	5	40
911.3568	3/32"	25,0	1	6
911.3613	3/32"	25,0	5	40
911.3569	7/64"	25,0	1	6
911.3614	7/64"	25,0	5	40
911.3570	1/8"	25,0	1	6
911.3615	1/8"	25,0	5	40
911.3571	9/64"	25,0	1	6
911.3616	9/64"	25,0	5	40
911.3572	5/32"	25,0	1	6
911.3617	5/32"	25,0	5	40
911.3573	3/16"	25,0	1	6
911.3618	3/16"	25,0	5	40
911.3574	7/32"	25,0	1	6
911.3619	7/32"	25,0	5	40
911.3575	1/4"	25,0	1	6
911.3620	1/4"	25,0	5	40
911.3576	5/16"	25,0	1	6
911.3621	5/16"	25,0	5	40
911.3577	3/8"	25,0	1	6
911.3622	3/8"	25,0	5	40



CLASSIC Bit for hexagon tamperproof screws

- Tamperproof hexagon
- External hexagon drive to DIN 3126 / ISO 1173 - C 6,3
- Can be used by hand or with an electric screwdriver
- Ideally suited for fittings in trade and industry
- Nickel plated
- Special steel



1/4"

	mm	L mm	Content	
911.2934	2,0	25,0	1	6
911.2935	2,0	25,0	5	40
911.2937	2,5	25,0	1	6
911.2938	2,5	25,0	5	40
911.2940	3,0	25,0	1	6
911.2941	3,0	25,0	5	40
911.2943	4,0	25,0	1	6
911.2944	4,0	25,0	5	40
911.2946	5,0	25,0	1	6
911.2947	5,0	25,0	5	40
911.2949	6,0	25,0	1	6
911.2950	6,0	25,0	5	40
911.2952	1/8"	25,0	1	6
911.2953	1/8"	25,0	5	40
911.2955	3/32"	25,0	1	6
911.2956	3/32"	25,0	5	40
911.2958	5/32"	25,0	1	6
911.2959	5/32"	25,0	5	40
911.2961	5/64"	25,0	1	6
911.2962	5/64"	25,0	5	40
911.2964	7/64"	25,0	1	6
911.2965	7/64"	25,0	5	40
911.2967	9/64"	25,0	1	6
911.2968	9/64"	25,0	5	40
911.3582	1/16"	25,0	1	6
911.3583	1/16"	25,0	5	40
911.3584	3/16"	25,0	1	6
911.3585	3/16"	25,0	5	40
911.3586	7/32"	25,0	1	6
911.3587	7/32"	25,0	5	40
911.3588	1/4"	25,0	1	6
911.3589	1/4"	25,0	5	40
911.3590	5/16"	25,0	1	6
911.3591	5/16"	25,0	5	40
911.3592	3/8"	25,0	1	6
911.3593	3/8"	25,0	5	40

CLASSIC bit for hexagon screws with ball end

- Hexagon socket with ball end
- With external hexagon drive to DIN 3126 / ISO 1173 - C 6,3
- Can be used by hand or with an electric screwdriver
- Ideally suited for fittings in trade and industry
- Nickel plated
- Special steel



1/4"

	mm	L mm	Content	
911.3700	2,5	25,0	1	6
911.3701	2,5	25,0	5	40
911.3702	3	25,0	1	6
911.3703	3	25,0	5	40
911.3704	4	25,0	1	6
911.3705	4	25,0	5	40
911.3706	5	25,0	1	6
911.3707	5	25,0	5	40
911.3708	6	25,0	1	6
911.3709	6	25,0	5	40
911.3710	3/32"	25,0	1	6
911.3711	3/32"	25,0	5	40
911.4651	7/64"	25,0	1	6
911.3713	7/64"	25,0	5	40
911.3714	1/8"	25,0	1	6
911.3715	1/8"	25,0	5	40
911.4652	9/64"	25,0	1	6
911.3717	9/64"	25,0	5	40
911.3718	5/32"	25,0	1	6
911.3719	5/32"	25,0	5	40
911.3720	3/16"	25,0	1	6
911.3721	3/16"	25,0	5	40
911.3722	7/32"	25,0	1	6
911.3723	7/32"	25,0	5	40
911.3724	1/4"	25,0	1	6
911.3725	1/4"	25,0	5	40

CLASSIC bit for Phillips screws PH

- PH
- With external hexagon drive to DIN 3126 / ISO 1173 - C 6,3
- Can be used by hand or with an electric screwdriver
- Ideally suited for fittings in trade and industry
- Nickel plated
- Special steel



1/4"

		L mm	Content	
911.3333	PH000	25,0	1	6
911.3334	PH000	25,0	5	40
911.3335	PH00	25,0	1	6
911.3336	PH00	25,0	5	40
911.2396	PH0	25,0	1	6
911.2394	PH0	25,0	5	40
911.2201	PH1	25,0	1	6
911.2202	PH1	25,0	5	40
911.2204	PH2	25,0	1	6
911.2205	PH2	25,0	5	40
911.2207	PH3	25,0	1	6
911.2208	PH3	25,0	5	40
911.3337	PH4	25,0	1	8
911.3338	PH4	25,0	5	50

1
2
3
4
5
6
7
8
9
10
11
12
13
14
15
16
17
18
19
20
21
22
23
24
25
26
27
i

CLASSIC bit for Phillips screws PZ

- PZ
- With external hexagon drive to DIN 3126 / ISO 1173 - C 6,3
- Can be used by hand or with an electric screwdriver
- Ideally suited for fittings in trade and industry
- Nickel plated
- Special steel

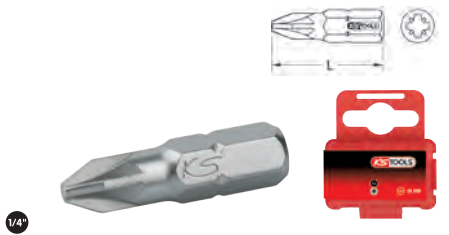

		L mm	Content	
911.2397	PZ0	25.0	1	6
911.2393	PZ0	25.0	5	40
911.2219	PZ1	25.0	1	6
911.2220	PZ1	25.0	5	40
911.2222	PZ2	25.0	1	6
911.2223	PZ2	25.0	5	40
911.2225	PZ3	25.0	1	6
911.2226	PZ3	25.0	5	40
911.3345	PZ4	25.0	1	8
911.3346	PZ4	25.0	5	50

CLASSIC bit for TX screws

- TX
- With external hexagon drive to DIN 3126 / ISO 1173 - C 6,3
- Can be used by hand or with an electric screwdriver
- Ideally suited for fittings in trade and industry
- Nickel plated
- Special steel

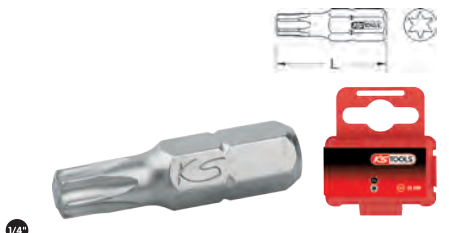

		L mm	Content	
911.3351	T1	25.0	1	6
911.3352	T1	25.0	5	40
911.3353	T2	25.0	1	6
911.3354	T2	25.0	5	40
911.3355	T3	25.0	1	6
911.3356	T3	25.0	5	40
911.3357	T4	25.0	1	6
911.3358	T4	25.0	5	40
911.3359	T5	25.0	1	6
911.3360	T5	25.0	5	40
911.2334	T6	25.0	1	6
911.2335	T6	25.0	5	40
911.2303	T7	25.0	1	6
911.2304	T7	25.0	5	40
911.2306	T8	25.0	1	6
911.2307	T8	25.0	5	40
911.2309	T9	25.0	1	6
911.2310	T9	25.0	5	40
911.2312	T10	25.0	1	6
911.2313	T10	25.0	5	40
911.2315	T15	25.0	1	6
911.2316	T15	25.0	5	40
911.2318	T20	25.0	1	6
911.2319	T20	25.0	5	40
911.2321	T25	25.0	1	6
911.2322	T25	25.0	5	40
911.2324	T27	25.0	1	6
911.2325	T27	25.0	5	40
911.2327	T30	25.0	1	8
911.2328	T30	25.0	5	50
911.2330	T40	25.0	1	8
911.2331	T40	25.0	5	50
911.3363	T45	25.0	1	8
911.3364	T45	25.0	5	50

CLASSIC bit for TX PLUS screws

- TX PLUS
- With external hexagon drive to DIN 3126 / ISO 1173 Form C 8
- Can be used by hand or with an electric screwdriver
- Ideally suited for fittings in trade and industry
- Reinforced execution
- Nickel plated
- Special steel



		L mm	Content	
911.3240	IP 10	30.0	1	5
911.3241	IP 15	30.0	1	6
911.3242	IP 20	30.0	1	5
911.3243	IP 25	30.0	1	5
911.3244	IP 30	30.0	1	5

CLASSIC bit for TX screws with ball end

- TX with ball end
- With external hexagon drive to DIN 3126 / ISO 1173 - C 6,3
- Can be used by hand or with an electric screwdriver
- Ideally suited for fittings in trade and industry
- Nickel plated
- Special steel



		L mm	Content	
911.3389	T10	25.0	1	6
911.3390	T10	25.0	5	40
911.3391	T15	25.0	1	6
911.3392	T15	25.0	5	40
911.3393	T20	25.0	1	6
911.3394	T20	25.0	5	40
911.3395	T25	25.0	1	6
911.3396	T25	25.0	5	40
911.3397	T30	25.0	1	8
911.3398	T30	25.0	5	50
911.3399	T40	25.0	1	8
911.3500	T40	25.0	5	50

CLASSIC bit for TX tamperproof screws

- For tamperproof TX
- External hexagon drive to DIN 3126 / ISO 1173 - C 6,3
- Can be used by hand or with an electric screwdriver
- Ideally suited for fittings in trade and industry
- Nickel plated
- Special steel

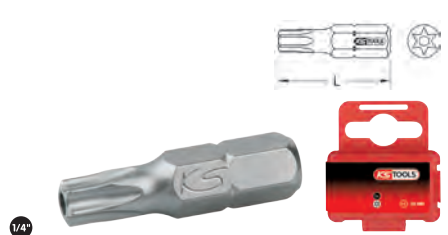

		L mm	Content	
911.2833	TB5	25.0	1	6
911.2836	TB6	25.0	1	6
911.2273	TB7	25.0	1	6
911.2274	TB7	25.0	5	40

		L mm	Content	
911.2276	TB8	25.0	1	6
911.2277	TB8	25.0	5	40
911.2279	TB9	25.0	1	6
911.2280	TB9	25.0	5	40
911.2282	TB10	25.0	1	6
911.2283	TB10	25.0	5	40
911.2285	TB15	25.0	1	6
911.2286	TB15	25.0	5	40
911.2288	TB20	25.0	1	6
911.2289	TB20	25.0	5	40
911.2291	TB25	25.0	1	6
911.2292	TB25	25.0	5	40
911.2294	TB27	25.0	1	6
911.2295	TB27	25.0	5	40
911.2297	TB30	25.0	1	8
911.2298	TB30	25.0	5	50
911.2300	TB40	25.0	1	8
911.2301	TB40	25.0	5	50

CLASSIC Bit for tamperproof five star bits

- Five star bit, tamperproof
- With external hexagon drive to DIN 3126 / ISO 1173 - C 6,3
- Can be used by hand or with an electric screwdriver
- Ideally suited for fittings in trade and industry
- Nickel plated
- Special steel

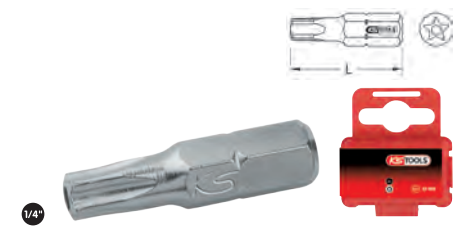

		L mm	Content	
911.3101	TS10	30.0	1	6
911.3111	TS10	30.0	5	40
911.3102	TS15	30.0	1	6
911.3112	TS15	30.0	5	40
911.3103	TS20	30.0	1	6
911.3113	TS20	30.0	5	40
911.3104	TS25	30.0	1	6
911.3114	TS25	30.0	5	40
911.3105	TS27	30.0	1	6
911.3115	TS27	30.0	5	40
911.3106	TS30	30.0	1	8
911.3116	TS30	30.0	5	50
911.3107	TS40	30.0	1	8
911.3117	TS40	30.0	5	50

CLASSIC bit for spline screws

- Spline
- External hexagon drive to DIN 3126 / ISO 1173 - C 6,3
- Can be used by hand or with an electric screwdriver
- Ideally suited for fittings in trade and industry
- Nickel plated
- Special steel

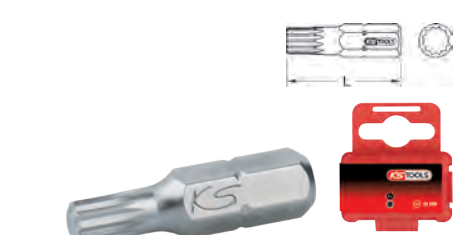

		L mm	Content	
911.2341	M4	25.0	1	6
911.2342	M4	25.0	5	40
911.2344	M5	25.0	1	6
911.2345	M5	25.0	5	40
911.2347	M6	25.0	1	8
911.2348	M6	25.0	5	50
911.2350	M8	25.0	1	8
911.2351	M8	25.0	5	50
911.2353	M10	25.0	1	8

CLASSIC bit for security screws

- Security
- External hexagon drive to DIN 3126 / ISO 1173 - C 6,3
- Can be used by hand or with and electric screwdriver
- Ideally suited for fittings in trade and industry
- Nickel plated
- Special steel

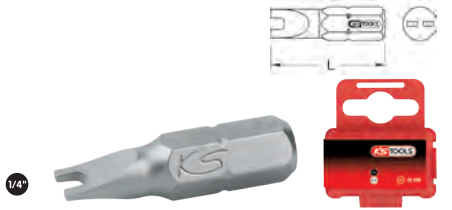

	mm	L mm	Content	
911.2910	4.0	25.0	1	6
911.2911	4.0	25.0	5	40
911.2913	6.0	25.0	1	6
911.2914	6.0	25.0	5	40
911.2916	8.0	25.0	1	8
911.2917	8.0	25.0	5	50
911.2919	10.0	25.0	1	8
911.2920	10.0	25.0	5	50
911.3594	12.0	25.0	1	8
911.3595	12.0	25.0	5	50

CLASSIC bit for RIBE® screws

- RIBE®
- External hexagon drive to DIN 3126 / ISO 1173 form C 8
- Can be used by hand, electric screwdriver and impact drivers
- Ideally suited for fittings in trade and industry
- Reinforced execution
- Phosphate finish
- Special steel



		L mm	Content	
911.5260	M4	25.0	1	10
911.5261	M5	25.0	1	10
911.5262	M6	25.0	1	10
911.5263	M7	25.0	1	10
911.5264	M8	25.0	1	10
911.5265	M9	25.0	1	10

CLASSIC bit for TRIWING® screws

- TRIWING®
- External hexagon drive to DIN 3126 / ISO 1173 - C 6,3
- Can be used by hand or with and electric screwdriver
- Ideally suited for fittings in trade and industry
- Nickel plated
- Special steel



	mm	L mm	Content	
911.3625	1,0	25,0	1	6
911.3626	1,0	25,0	5	40
911.3627	2,0	25,0	1	6
911.3628	2,0	25,0	5	40
911.3629	3,0	25,0	1	6
911.3630	3,0	25,0	5	40
911.2922	4,0	25,0	1	6
911.2923	4,0	25,0	5	40
911.3596	5,0	25,0	1	6
911.3597	5,0	25,0	5	40
911.2925	6,0	25,0	1	6
911.2926	6,0	25,0	5	40
911.2928	8,0	25,0	1	8
911.2929	8,0	25,0	5	50
911.2931	10,0	25,0	1	8
911.2932	10,0	25,0	5	50

CLASSIC bit for Torq® screws

- Torq®
- External hexagon drive to DIN 3126 / ISO 1173 - C 6,3
- Can be used by hand or with and electric screwdriver
- Ideally suited for fittings in trade and industry
- Nickel plated
- Special steel

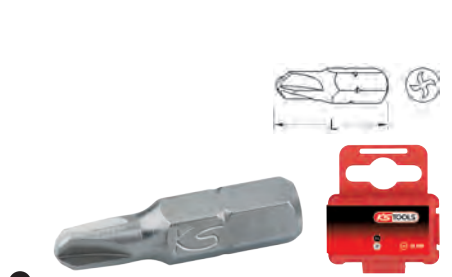

	mm	L mm	Content	
911.3631	1.0	25.0	1	6
911.3632	1.0	25.0	5	40
911.3633	2.0	25.0	1	6
911.3634	2.0	25.0	5	40
911.3635	3.0	25.0	1	6
911.3636	3.0	25.0	5	40
911.3637	4.0	25.0	1	6
911.3638	4.0	25.0	5	40
911.3639	5.0	25.0	1	6
911.3640	5.0	25.0	5	40
911.2901	6.0	25.0	1	6
911.2902	6.0	25.0	5	40
911.2904	8.0	25.0	1	8
911.2905	8.0	25.0	5	50
911.2907	10.0	25.0	1	8
911.2908	10.0	25.0	5	50

1/4" CLASSIC BIT SETS 25 mm

CLASSIC mini bit case

- Compact and handy design - fits into shirt or trouser pocket
- Ergonomic form for fatigue free working
- Integrated hexagon drive in the magazine can be used as an auxiliary screwdriver
- Folding bit magazine
- Includes AUTO SLIMLOCK bitholder with magnet and extension
- Extremely slim ideal in confined spaces
- Precise and orderly arrangement of the popular 1/4" bits
- Can be used by hand or with and electric screwdriver
- Ideally suited for fittings in trade and industry
- Bits with external hexagon drive to DIN 3126 / ISO 1173 - C 6,3
- Nickel plated bits
- Bits made of special steel
- Box made from impact resistant plastic



	Content	
911.2840	11 pcs CLASSIC mini bit case	130
2 x	5,5 - 6,5 mm	
4 x	PH1 - 2 x PH2 - PH3	
4 x	PZ1 - 2 x PZ2 - PZ3	
1 x	1/4"	

CLASSIC mini bit case display

- Compact and handy design - fits into shirt or trouser pocket
- Ergonomic form for fatigue free working
- Integrated hexagon drive in the magazine can be used as an auxiliary screwdriver
- Folding bit magazine
- Includes AUTO SLIMLOCK bitholder with magnet and extension
- Extremely slim ideal in confined spaces
- Precise and orderly arrangement of the popular 1/4" bits
- Can be used by hand or with and electric screwdriver
- Ideally suited for fittings in trade and industry
- Bits with external hexagon drive to DIN 3126 / ISO 1173 - C 6,3
- Nickel plated bits
- Bits made of special steel
- Box made from impact resistant plastic
- Supplied in counter sales display



	Content	
911.2840D	12 pcs 12 x 911.2840D	1.85

CLASSIC mini bit case

- Compact and handy design - fits into shirt or trouser pocket
- Ergonomic form for fatigue free working
- Integrated hexagon drive in the magazine can be used as an auxiliary screwdriver
- Folding bit magazine
- Includes AUTO SLIMLOCK bitholder with magnet and extension
- Extremely slim ideal in confined spaces
- Precise and orderly arrangement of the popular 1/4" bits
- Can be used by hand or with and electric screwdriver
- Ideally suited for fittings in trade and industry
- Bits with external hexagon drive to DIN 3126 / ISO 1173 - C 6,3
- Nickel plated bits
- Bits made of special steel
- Box made from impact resistant plastic



	Content	
911.2845	11 pcs CLASSIC mini bit case	130
4 x	T15 - T20 - T25 - T30	
3 x	PH1 - PH2 - PH3	
3 x	PZ1 - PZ2 - PZ3	
1 x	1/4"	

CLASSIC mini bit case display

- Compact and handy design - fits into shirt or trouser pocket
- Ergonomic form for fatigue free working
- Integrated hexagon drive in the magazine can be used as an auxiliary screwdriver
- Folding bit magazine
- Includes AUTO SLIMLOCK bitholder with magnet and extension
- Extremely slim ideal in confined spaces
- Precise and orderly arrangement of the popular 1/4" bits
- Can be used by hand or with and electric screwdriver
- Ideally suited for fittings in trade and industry
- Bits with external hexagon drive to DIN 3126 / ISO 1173 - C 6,3
- Nickel plated bits
- Bits made of special steel
- Box made from impact resistant plastic
- Supplied in counter sales display



1/4"			
			kg
911.2845D	12 pcs	12 x 911.2845	1.85

CHROMEplus® bit set

- External hexagon drive to DIN 3126 / ISO 1173 - C 6,3
- Can be used by hand or with and electric screwdriver
- Includes reversing GEARplus® bit ratchet ring spanner and 1/4" socket adaptor
- Ideally suited for fittings in trade and industry
- Precise and orderly arrangement of the popular 1/4" bits
- Chrome plated
- Special steel
- Includes mirror polished chrome box



1/4"			
			kg
918.4520	20 pcs	CHROMEplus® bit set	0.32
1 x		1/4" x 1/4"	
1 x		1/4"	
3 x		PH1 - PH2 - PH3	
3 x		PZ1 - PZ2 - PZ3	
3 x		4,5 - 5,5 - 6,5 mm	
3 x		4 - 5 - 6 mm	
6 x		TB10 - TB15 - TB20 - TB25 - TB30 - TB40	

CHROMEplus® bit set display

- External hexagon drive to DIN 3126 / ISO 1173 - C 6,3
- Can be used by hand or with and electric screwdriver
- Includes reversing GEARplus® bit ratchet ring spanner and 1/4" socket adaptor
- Ideally suited for fittings in trade and industry
- Precise and orderly arrangement of the popular 1/4" bits
- Chrome plated
- Special steel
- Includes mirror polished chrome box
- Supplied in counter sales display



1/4"			
			kg
918.4520D	12 pcs	12 x 918.4520	3.20

CHROMEplus® bit set

- External hexagon drive to DIN 3126 / ISO 1173 - C 6,3
- Can be used by hand or with and electric screwdriver
- Includes magnetic quick release bit holder and 1/4" socket adaptor
- Ideally suited for fittings in trade and industry
- Precise and orderly arrangement of the popular 1/4" bits
- Nickel plated
- Special steel
- Includes mirror polished chrome box



1/4"			
			kg
911.2070	30 pcs	CHROMEplus® bit set	0.26
1 x		1/4"	
1 x		1/4"	
4 x		PH1 - 2 x PH2 - PH3	
4 x		PZ1 - 2 x PZ2 - PZ3	
3 x		4,5 - 5,5 - 6,5 mm	
3 x		4 - 5 - 6 mm	
7 x		TB10 - TB15 - TB20 - TB25 - TB27 - TB30 - TB40	
7 x		T10 - T15 - T20 - T25 - T27 - T30 - T40	

CLASSIC bit set

- External hexagon drive to DIN 3126 / ISO 1173 - C 6,3
- Can be used by hand or with and electric screwdriver
- Includes magnetic quick release bit holder and 1/4" socket adaptor
- Practical belt holder
- Ideally suited for fittings in trade and industry
- Precise and orderly arrangement of the popular 1/4" bits
- Nickel plated
- Special steel
- In durable plastic storage case



1/4"			
			kg
911.2060	32 pcs	CLASSIC bit set	0.30
1 x		1/4"	
1 x		1/4"	
3 x		PH1 - PH2 - PH3	
6 x		2 x PZ1 - 2 x PZ2 - 2 x PZ3	
3 x		5,5 - 6,5 - 8 mm	
3 x		4 - 5 - 6 mm	
15 x		2 x TB10 - 3 x TB15 - 2 x TB20 - 3 x TB25 - 3 x TB30 - 2 x TB40	

CHROMEplus® bit set

- Can be used by hand or with an electric screwdriver
- Ideally suited for fittings in trade and industry
- Precise arrangement of the popular 1/4" bits
- Exact gearing with 72 teeth
- Offset angle 5°
- Matt finish
- Chrome vanadium
- In high quality chrome box



1/4"			
			kg
918.4600	31 pcs	CHROMEplus® bit set	0.60
1 x		1/4"	
1 x		1/4"	
1 x		1/4"	
4 x		PH 1 - 2 x PH 2 - PH 3	
4 x		PZ 1 - 2 x PZ 2 - PZ 3	
3 x		4,5 - 5,5 - 6,5 mm	
3 x		4 - 5 - 6 mm	
7 x		T10 - T15 - T20 - T25 - T27 - T30 - T40	
7 x		TB10 - TB15 - TB20 - TB25 - TB27 - TB30 - TB40	

CHROMEplus® bit set

- External hexagon drive to DIN 3126 / ISO 1173 - C 6,3
- Can be used by hand or with and electric screwdriver
- Includes CHROMEplus® mini bit reversing ratchet and 1/4" socket adaptor
- Ideally suited for fittings in trade and industry
- Precise and orderly arrangement of the popular 1/4" bits
- Chrome plated
- Special steel
- Includes mirror polished chrome box



1/4"

				kg
918.4500	31 pcs	CHROMEplus® bit set		0.60
1 x		1/4" x 1/4"		
1 x		1/4"		
1 x		1/4"		
3 x		PH1 - PH2 - PH3		
3 x		PZ1 - PZ2 - PZ3		
3 x		4,5 - 5,5 - 6,5 mm		
3 x		4 - 5 - 6 mm		
7 x		TB10 - TB15 - TB20 - TB25 - TB27 - TB30 - TB40		
7 x		T10 - T15 - T20 - T25 - T27 - T30 - T40		

CHROMEplus® bit set display

- External hexagon drive to DIN 3126 / ISO 1173 - C 6,3
- Can be used by hand or with and electric screwdriver
- Includes CHROMEplus® bit reversing ratchet and 1/4" socket adaptor
- Ideally suited for fittings in trade and industry
- Precise and orderly arrangement of the popular 1/4" bits
- Chrome plated
- Special steel
- Includes mirror polished chrome box and belt pouch
- Supplied in counter sales display



1/4"

				kg
918.4500D	11 pcs	11 x 918.4500		6.60

CLASSIC bit set

- External hexagon drive to DIN 3126 / ISO 1173 - C 6,3
- Can be used by hand or with and electric screwdriver
- Includes quick release screwdriver bits and 1/4" socket adaptor
- Ideally suited for fittings in trade and industry
- Precise and orderly arrangement of the popular 1/4" security bits
- Nickel plated
- Special steel
- In durable steel storage case



1/4"

				kg
911.2029	29 pcs	CLASSIC bit set		0.88
1 x		1/4"		
1 x		1/4"		
9 x		TB8 - TB9 - TB10 - TB15 - TB20 - TB25 - TB27 - TB30 - TB40		
6 x		2 - 2,5 - 3 - 4 - 5 - 6 mm		
4 x		4 - 6 - 8 - 10 mm		
4 x		4 - 6 - 8 - 10 mm		
3 x		6 - 8 - 10 mm		
1 x		1/4"		

CLASSIC bit and drive socket set

- Ideal set of compilation for plumbing heating and air conditioning
- External hexagon drive to DIN 3126 / ISO 1173 - C 6,3
- Can be used by hand or with and electric screwdriver
- Ideally suited for fittings in trade and industry
- Includes magnetic drive sockets and stud screwdrivers for a damage free inserting boring and unscrewing bolts and stud bolts
- Orderly arrangement of the popular 1/4" bits and drive sockets
- Sand blasted
- Special steel
- In durable plastic storage case



1/4"

				kg
122.2100	31 pcs	CLASSIC bit and drive socket set		0.67
4 x		7 - 8 - 10 - 13 mm		
4 x		M6 - M8 - M10 - M12		
1 x		50 mm		
5 x		PH1 - 3 x PH2 - PH3		
5 x		PZ1 - 3 x PZ2 - PZ3		
2 x		5,5 - 6,5 mm		
3 x		4 - 5 - 6 mm		
7 x		T10 - T15 - T20 - T25 - T27 - T30 - T40		

CLASSIC bit and drive socket display

- Ideal set of compilation for plumbing heating and air conditioning
- External hexagon drive to DIN 3126 / ISO 1173 - C 6,3
- Can be used by hand or with and electric screwdriver
- Ideally suited for fittings in trade and industry
- Includes magnetic drive sockets and stud screwdrivers for a damage free inserting boring and unscrewing bolts and stud bolts
- Orderly arrangement of the popular 1/4" bits and drive sockets
- Special steel
- Supplied in counter sales display



1/4"

				kg
122.2100D	10 pcs	10 x 122.2100		7.00



1
2
3
4
5
6
7
8
9
10
11
12
13
14
15
16
17
18
19
20
21
22
23
24
25
26
27

CLASSIC bit set

- External hexagon drive to DIN 3126 / ISO 1173 - C 6,3
- Can be used by hand or with and electric screwdriver
- Includes bitholder and 1/4" socket adaptor
- Ideally suited for fittings in trade and industry
- Orderly arrangement of the popular 1/4" bits
- Sand blasted
- Special steel
- In durable plastic storage case



CLASSIC Bit set

- External hexagon drive to DIN 3126 / ISO 1173 - C 6,3
- Can be used by hand or with and electric screwdriver
- Includes bit holder, bit ratchet, 1/4" socket adaptor and 1/4" bit screwdriver
- Ideally suited for fittings in trade and industry
- Precise and orderly arrangement of the popular 1/4" bits
- Sand blasted
- Special steel
- In durable plastic storage case

CLASSIC bit set

- With external hexagon drive to DIN 3126 / ISO 1173 - C 6,3
- Can be used by hand or with and electric screwdriver
- Includes bit holder, bit ratchet, 1/4" socket adaptor and 1/4" mini-bit-screwdriver
- Ideally suited for fittings in trade and industry
- Precise and orderly arrangement of the popular 1/4" bits
- Sand-blasted
- Special steel
- In durable plastic storage case



1/4"

911.2026		100 pcs	CLASSIC bit set	0.75
1 x		50 mm		
2 x		30 - 50 mm		
1 x		1/4"		
1 x		1/4"		
9 x		3 - 4 - 4,5 - 5 - 5,5 - 6 - 6,5 - 7 - 8 mm		
8 x		PH0 - PH1 - 5 x PH2 - PH3		
8 x		PZ0 - PZ1 - 5 x PZ2 - PZ3		
9 x		1,5 - 2 - 2,5 - 3 - 4 - 5 - 5,5 - 6 - 8 mm		
10 x		1/16" - 5/64" - 3/32" - 7/64" - 1/8" - 9/64" - 5/32" - 3/16" - 7/32" - 1/4"		
6 x		2 - 2,5 - 3 - 4 - 5 - 6 mm		
6 x		5/64" - 3/32" - 7/64" - 1/8" - 9/64" - 5/32"		
9 x		T8 - T10 - T15 - T20 - T25 - T27 - T30 - T35 - T40		
9 x		TB8 - TB10 - TB15 - TB20 - TB25 - TB27 - TB30 - TB35 - TB40		
3 x		M5 - M6 - M8		
3 x	#1-#3 bits"/>	#1 - #2 - #3		
4 x	#1-#4 bits"/>	#1 - #2 - #3 - #4		
4 x		4 - 6 - 8 - 10 mm		
3 x		6 - 8 - 10 mm		
4 x	#0-#3 bits"/>	#0 - #1 - #2 - #3		

1/4"

911.2080		99 pcs	CLASSIC bit set	0.75
1 x		1/4"		
1 x		1/4"		
1 x		1/4"		
1 x		1/4"		
9 x		3 - 4 - 4,5 - 5 - 5,5 - 6 - 6,5 - 7 - 8 mm		
8 x		PH0 - PH1 - 5 x PH2 - PH3		
8 x		PZ0 - PZ1 - 5 x PZ2 - PZ3		
9 x		1,5 - 2 - 2,5 - 3 - 4 - 5 - 5,5 - 6 - 8 mm		
10 x		5/64" - 7/64" - 9/64" - 3/32" - 5/32" - 7/32" - 3/16" - 1/16" - 1/8" - 1/4"		
6 x		2 - 2,5 - 3 - 4 - 5 - 6 mm		
6 x		5/64" - 7/64" - 9/64" - 3/32" - 1/8" - 5/32"		
9 x		T8 - T10 - T15 - T20 - T25 - T27 - T30 - T40 - T45		
9 x		TB8 - TB10 - TB15 - TB20 - TB25 - TB27 - TB30 - TB35 - TB40		
3 x		M5 - M6 - M8		
3 x	#1-#3 bits"/>	#1 - #2 - #3		
4 x	#1-#4 bits"/>	#1 - #2 - #3 - #4		
4 x		4 - 6 - 8 - 10 mm		
3 x		6 - 8 - 10 mm		
4 x	#0-#3 bits"/>	#0 - #1 - #2 - #3		

1/4"

911.2085		122 pcs	CLASSIC Bit set	1.15
1 x		1/4"		
1 x		1/4"		
1 x		1/4"		
2 x		30 - 50 mm		
1 x		1/4"		
10 x		4 - 5 - 6 - 7 - 8 - 9 - 10 - 11 - 12 - 13 mm		
10 x		5/32" - 3/16" - 7/32" - 1/4" - 9/32" - 5/16" - 1/2"		
9 x		3 - 4 - 4,5 - 5 - 5,5 - 6 - 6,5 - 7 - 8 mm		
5 x		PH0 - PH00 - PH1 - PH2 - PH3		
5 x		PZ0 - PZ00 - PZ1 - PZ2 - PZ3		
9 x		1,5 - 2 - 2,5 - 3 - 4 - 5 - 5,5 - 6 - 8 mm		
10 x		1/16" - 5/64" - 3/32" - 7/64" - 1/8" - 9/64" - 5/32" - 3/16" - 7/32" - 1/4"		
6 x		2 - 2,5 - 3 - 4 - 5 - 6 - 8 mm		
13 x		T5 - T6 - T7 - T8 - T9 - T10 - T15 - T20 - T25 - T27 - T30 - T40 - T45		
9 x		TB8 - TB10 - TB15 - TB20 - TB25 - TB27 - TB30 - TB35 - TB40		
3 x		M5 - M6 - M8		
3 x	#1-#3 bits"/>	#1 - #2 - #3		
4 x		4 - 6 - 8 - 10 mm		
4 x		4 - 6 - 8 - 10 mm		
3 x		6 - 8 - 10 mm		
4 x	#0-#3 bits"/>	#0 - #1 - #2 - #3		
9 x		TS10 - TS15 - TS20 - TS25 - TS27 - TS30 - TS40 - TS45 - TS50		

CLASSIC bit set

- External hexagon drive to DIN 3126 / ISO 1173 - C 6,3
- Can be used by hand or with and electric screwdriver
- Includes bitholder and 1/4" socket adapter
- Ideally suited for fittings in trade and industry
- Orderly arrangement of the popular 1/4" bits
- Sand blasted
- Special steel
- In durable plastic storage case



1/4"

911.2027 99 pcs CLASSIC bit set 0.75			
1 x		1/4"	
1 x		1/4"	
1 x		1/4"	
9 x		3 - 4 - 4,5 - 5 - 5,5 - 6 - 6,5 - 7 - 8	
5 x		PH0 - PH1 - 2 x PH2 - PH3	
5 x		PZ0 - PZ1 - 2 x PZ2 - PZ3	
9 x		1,5 - 2 - 2,5 - 3 - 4 - 5 - 5,5 - 6 - 8	
6 x		2 - 2,5 - 3 - 4 - 5 - 6	
6 x		5/64" - 3/32" - 7/64" - 1/8" - 9/64" - 5/32"	
9 x		T8 - T10 - T15 - T20 - T25 - T27 - T30 - T40 - T45	
9 x		TB8 - TB10 - TB15 - TB20 - TB25 - TB27 - TB30 - TB35 - TB40	
3 x		M5 - M6 - M8	
3 x		#1 - #2 - #3	
4 x		#1 - #2 - #3 - #4	
4 x		4 - 6 - 8 - 10 mm	
3 x		6 - 8 - 10 mm	
4 x		#0 - #1 - #2 - #3	
3 x		4 - 5 - 6 mm	
3 x		TB15 - TB20 - TB30	
4 x		#1 - #2 - #3 - 4 #	
4 x		4 - 6 - 8 - 10 mm	
3 x		6 - 8 - 10 mm	

CLASSIC bit set

- External hexagon drive to DIN 3126 / ISO 1173 - C 6,3
- Can be used by hand or with and electric screwdriver
- Includes quick release bit holder
- Ideally suited for fittings in trade and industry
- Orderly arrangement of the popular 1/4" bits
- Sand blasted
- Special steel
- In durable plastic storage case



1/4"

911.2031 113 pcs CLASSIC bit set 1.17			
1 x		1/4"	
1 x		1/4"	
3 x		PH2	
3 x		PZ2	
7 x		T10 - T15 - 3 x T20 - T25 - T30	
14 x		7 x 4 - 7 x 6 mm	
21 x		7 x PH1 - 7 x PH2 - 7 x PH3	
21 x		7 x PZ1 - 7 x PZ2 - 7 x PZ3	
21 x		7 x 4 - 7 x 5 - 7 x 6 mm	
14 x		2 x T10 - 2 x T15 - 2 x T20 - 2 x T25 - 2 x T27 - 2 x T30 - 2 x T40	
7 x		T10 - T15 - T20 - T25 - T27 - T30 - T40	

CLASSIC bit display

- External hexagon drive to DIN 3126 / ISO 1173 - C 6,3
- Can be used by hand or with and electric screwdriver
- Ideally suited for fittings in trade and industry
- Contains the most current 1/4" bits and bit holder
- Nickel plated
- Special steel
- In durable plastic storage bit magazine
- 30 Drawers with labels
- Magazine can be placed or can secured to the wall
- Polypropylene housing
- Drawers out of polystyrene



1/4"

911.2200 280 pcs CLASSIC bit display 6.60			
10 x		5 x 50 - 5 x 100 mm	
5 x		65 mm	

5 x		65 mm	
30 x		10 x 4 - 10 x 5,5 - 10 x 6,5 mm	
30 x		10 x 4 - 10 x 5 - 10 x 6 mm	
30 x		10 x PH1 - 10 x PH2 - 10 x PH3	
30 x		10 x PZ1 - 10 x PZ2 - 10 x PZ3	
70 x		10 x (T10 - T15 - T20 - T25 - T27 - T30 - T40)	
70 x		10 x (TB10 - TB15 - TB20 - TB25 - TB27 - TB30 - TB40)	



CLASSIC bit display

- External hexagon drive to DIN 3126 / ISO 1173 - C 6,3
- Can be used by hand or with and electric screwdriver
- Ideally suited for fittings in trade and industry
- Contains the most current 1/4" bits and bit holder
- Nickel plated
- Special steel
- In durable clear acrylic counter display with a push cover



1/4"

911.2000 1580 pcs CLASSIC bit display 10.10			
10 x		60 mm	
10 x		65 mm	
200 x		50 x PH1 - 100 x PH2 - 50 x PH3	
200 x		50 x PZ1 - 100 x PZ2 - 50 x PZ3	
230 x		50 x 4 mm - 100 x 5,5 mm - 50 x 6,5 mm - 30 x 8 mm	
230 x		50 x (3 - 4 - 5 - 6 mm) - 30 x 8 mm	
350 x		50 x (T10 - T15 - T20 - T25 - T27 - T30 - T40)	
350 x		50 x (TB10 - TB15 - TB20 - TB25 - TB27 - TB30 - TB40)	

1/4" CLASSIC BITS 50 mm

CLASSIC bit for slotted screws

- Slotted
- External hexagon drive to DIN 3126 / ISO 1173 - E 6,3
- Can be used by hand or with and electric screwdriver
- Ideally suited for fittings in trade and industry
- Nickel plated
- Special steel

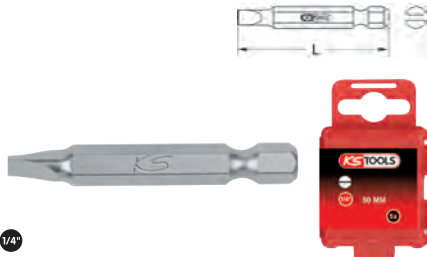

	mm	L mm	Content	
911.3315	1.5	50.0	1	10
911.3316	1.5	50.0	5	60
911.3317	2.0	50.0	1	10
911.3318	2.0	50.0	5	60
911.3319	2.5	50.0	1	10
911.3320	2.5	50.0	5	60
911.2746	3.0	50.0	1	10
911.2747	3.0	50.0	5	60
911.3321	3.5	50.0	1	10
911.3322	3.5	50.0	5	60
911.2749	4.0	50.0	1	10
911.2750	4.0	50.0	5	60
911.2752	4.5	50.0	1	10
911.2753	4.5	50.0	5	60
911.2755	5.0	50.0	1	10
911.2756	5.0	50.0	5	60
911.2758	5.5	50.0	1	10
911.2759	5.5	50.0	5	60
911.2761	6.0	50.0	1	10
911.2762	6.0	50.0	5	60
911.2764	6.5	50.0	1	12
911.2765	6.5	50.0	5	70
911.2767	7.0	50.0	1	12
911.2768	7.0	50.0	5	70
911.3323	8.0	50.0	1	12
911.3324	8.0	50.0	5	70
911.3325	9.0	50.0	1	12
911.3326	9.0	50.0	5	70
911.3327	10.0	50.0	1	12
911.3328	10.0	50.0	5	70
911.3329	11.0	50.0	1	12
911.3330	11.0	50.0	5	70
911.3331	12.0	50.0	1	12
911.3332	12.0	50.0	5	70



CLASSIC bit for hexagon screws

- Hexagon socket
- External hexagon drive to DIN 3126 / ISO 1173 - E 6,3
- Can be used by hand or with and electric screwdriver
- Ideally suited for fittings in trade and industry
- Nickel plated
- Special steel



	mm	L mm	Content	
911.2800	1,5	50,0	1	10
911.2801	1,5	50,0	5	60
911.2803	2,0	50,0	1	10
911.2804	2,0	50,0	5	60
911.2806	2,5	50,0	1	10
911.2807	2,5	50,0	5	60
911.2809	3,0	50,0	1	10
911.2810	3,0	50,0	5	60
911.2812	4,0	50,0	1	10
911.2813	4,0	50,0	5	60
911.2815	5,0	50,0	1	10
911.2816	5,0	50,0	5	60
911.2818	5,5	50,0	1	10
911.2819	5,5	50,0	5	60
911.2821	6,0	50,0	1	10
911.2822	6,0	50,0	5	60
911.2824	7,0	50,0	1	12
911.2825	7,0	50,0	5	70
911.3578	8,0	50,0	1	12
911.3579	8,0	50,0	5	70
911.3580	10,0	50,0	1	12
911.3581	10,0	50,0	5	70

CLASSIC bit for phillips screws PH

- PH
- External hexagon drive to DIN 3126 / ISO 1173 - E 6,3
- Can be used by hand or with and electric screwdriver
- Ideally suited for fittings in trade and industry
- Nickel plated
- Special steel

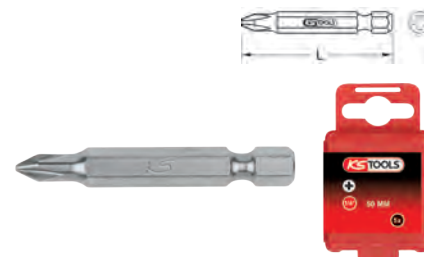

		L mm	Content	
911.3339	PH0	50.0	1	10
911.3340	PH0	50.0	5	60
911.2210	PH1	50.0	1	10
911.2211	PH1	50.0	5	60
911.2213	PH2	50.0	1	10
911.2214	PH2	50.0	5	60
911.2216	PH3	50.0	1	10
911.2217	PH3	50.0	5	60
911.3341	PH4	50.0	1	12
911.3342	PH4	50.0	5	70



CLASSIC bit for phillips screws PZ

- PZ
- External hexagon drive to DIN 3126 / ISO 1173 - E 6,3
- Ideally suited for fittings in trade and industry
- Can be used by hand or with and electric screwdriver
- Nickel plated
- Special steel



		L mm	Content	
911.3347	PZ0	50.0	1	10
911.3348	PZ0	50.0	5	60
911.2228	PZ1	50.0	1	10
911.2229	PZ1	50.0	5	60
911.2231	PZ2	50.0	1	10
911.2232	PZ2	50.0	5	60
911.2234	PZ3	50.0	1	10
911.2235	PZ3	50.0	5	60
911.3349	PZ4	50.0	1	12
911.3350	PZ4	50.0	5	70

CLASSIC bit for spline screws

- Spline
- External hexagon drive to DIN 3126 / ISO 1173 - E 6,3
- Ideally suited for fittings in trade and industry
- Can be used by hand or with and electric screwdriver
- Nickel plated
- Special steel



		L mm	Content	
911.2701	M3	50.0	1	10
911.2702	M3	50.0	5	60
911.2704	M4	50.0	1	10
911.2705	M4	50.0	5	60
911.2707	M5	50.0	1	10
911.2708	M5	50.0	5	60
911.2710	M6	50.0	1	12
911.2711	M6	50.0	5	70
911.2713	M8	50.0	1	12
911.2714	M8	50.0	5	70



CLASSIC bit for TX screws

- TX
- External hexagon drive to DIN 3126 / ISO 1173 - E 6,3
- Ideally suited for fittings in trade and industry
- Can be used by hand or with and electric screwdriver
- Nickel plated
- Special steel



1/4"

		L mm	Content	
911.3365	T1	50.0	1	10
911.3366	T1	50.0	5	60
911.3367	T2	50.0	1	10
911.3368	T2	50.0	5	60
911.3369	T3	50.0	1	10
911.3370	T3	50.0	5	60
911.3371	T4	50.0	1	10
911.3372	T4	50.0	5	60
911.3373	T5	50.0	1	10
911.3374	T5	50.0	5	60
911.3375	T6	50.0	1	10
911.3376	T6	50.0	5	60
911.2716	T7	50.0	1	10
911.2717	T7	50.0	5	60
911.2719	T8	50.0	1	10
911.2720	T8	50.0	5	60
911.2722	T9	50.0	1	10
911.2723	T9	50.0	5	60
911.2725	T10	50.0	1	10
911.2726	T10	50.0	5	60
911.2728	T15	50.0	1	10
911.2729	T15	50.0	5	60
911.2731	T20	50.0	1	10
911.2732	T20	50.0	5	60
911.2734	T25	50.0	1	10
911.2735	T25	50.0	5	60
911.2737	T27	50.0	1	10
911.2738	T27	50.0	5	60
911.2740	T30	50.0	1	12
911.2741	T30	50.0	5	70
911.2743	T40	50.0	1	12
911.2744	T40	50.0	5	70

CLASSIC bit for TX tamperproof screws

- For tamperproof TX
- External hexagon drive to DIN 3126 / ISO 1173 - E 6,3
- Ideally suited for fittings in trade and industry
- Can be used by hand or with and electric screwdriver
- Nickel plated
- Special steel



1/4"

		L mm	Content	
911.2770	TB7	50.0	1	10
911.2771	TB7	50.0	5	60
911.2773	TB8	50.0	1	10
911.2774	TB8	50.0	5	60
911.2776	TB9	50.0	1	10
911.2777	TB9	50.0	5	60
911.2779	TB10	50.0	1	10
911.2780	TB10	50.0	5	60
911.2782	TB15	50.0	1	10
911.2783	TB15	50.0	5	60
911.2785	TB20	50.0	1	10
911.2786	TB20	50.0	5	60
911.2788	TB25	50.0	1	10
911.2789	TB25	50.0	5	60
911.2791	TB27	50.0	1	10
911.2792	TB27	50.0	5	60
911.2794	TB30	50.0	1	12
911.2795	TB30	50.0	5	70
911.2797	TB40	50.0	1	12
911.2798	TB40	50.0	5	70

1/4" CLASSIC BITS 75 mm

CLASSIC bit for slotted screws

- Slotted
- External hexagon drive to DIN 3126 / ISO 1173 - E 6,3
- Can be used by hand or with and electric screwdriver
- Ideally suited for fittings in trade and industry
- Nickel plated
- Special steel



1/4"

	mm	L mm	Content	
911.7533	3.0	75.0	1	20
911.7733	3.0	75.0	5	110
911.7534	4.0	75.0	1	20
911.7734	4.0	75.0	5	110
911.7535	5.0	75.0	1	20
911.7735	5.0	75.0	5	110
911.7536	6.0	75.0	1	20
911.7736	6.0	75.0	5	110
911.7537	7.0	75.0	1	25
911.7737	7.0	75.0	5	140

CLASSIC bit for hexagon screws

- Hexagon socket
- External hexagon drive to DIN 3126 / ISO 1173 - E 6,3
- Can be used by hand or with and electric screwdriver
- Ideally suited for fittings in trade and industry
- Nickel plated
- Special steel



1/4"

	mm	L mm	Content	
911.7558	2,0	75,0	1	20
911.7758	2,0	75,0	5	110
911.7559	2,5	75,0	1	20
911.7759	2,5	75,0	5	110
911.7560	3,0	75,0	1	20
911.7760	3,0	75,0	5	110
911.7561	4,0	75,0	1	20
911.7761	4,0	75,0	5	110
911.7562	5,0	75,0	1	20
911.7762	5,0	75,0	5	110
911.7563	6,0	75,0	1	20
911.7763	6,0	75,0	5	110

CLASSIC bit for phillips screws PH

- PH
- External hexagon drive to DIN 3126 / ISO 1173 - E 6,3
- Can be used by hand or with and electric screwdriver
- Ideally suited for fittings in trade and industry
- Nickel plated
- Special steel



1/4"

		L mm	Content	
911.7530	PH1	75.0	1	20
911.7730	PH1	75.0	5	110
911.7531	PH2	75.0	1	20
911.7731	PH2	75.0	5	110
911.7539	PH3	75.0	1	20
911.7739	PH3	75.0	5	110



CLASSIC bit for phillips screws PZ

- PZ
- External hexagon drive to DIN 3126 / ISO 1173 - E 6,3
- Can be used by hand or with and electric screwdriver
- Ideally suited for fittings in trade and industry
- Nickel plated
- Special steel

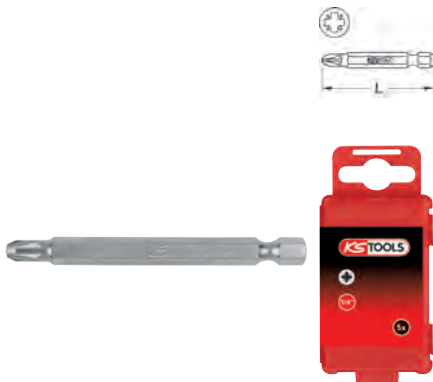

1/4"

		L mm	Content	
911.7527	PZ1	75.0	1	20
911.7727	PZ1	75.0	5	110
911.7528	PZ2	75.0	1	20
911.7728	PZ2	75.0	5	110
911.7529	PZ3	75.0	1	20
911.7729	PZ3	75.0	5	110

CLASSIC bit for TX screws

- TX
- External hexagon drive to DIN 3126 / ISO 1173 - E 6,3
- Can be used by hand or with and electric screwdriver
- Ideally suited for fittings in trade and industry
- Nickel plated
- Special steel



1/4"

		L mm	Content	
911.3377	T7	75.0	1	20
911.3378	T7	75.0	5	110
911.3379	T8	75.0	1	20
911.3380	T8	75.0	5	110
911.3381	T9	75.0	1	20
911.3382	T9	75.0	5	110
911.7551	T10	75.0	1	20
911.7751	T10	75.0	5	110
911.7552	T15	75.0	1	20
911.7752	T15	75.0	5	110
911.7553	T20	75.0	1	20
911.7753	T20	75.0	5	110
911.7554	T25	75.0	1	20
911.7754	T25	75.0	5	110
911.7555	T27	75.0	1	20
911.7755	T27	75.0	5	110
911.7556	T30	75.0	1	25
911.7756	T30	75.0	5	140
911.7557	T40	75.0	1	25
911.7757	T40	75.0	5	140

CLASSIC bit for TX tamperproof screws

- For tamperproof TX
- External hexagon drive to DIN 3126 / ISO 1173 - E 6,3
- Can be used by hand or with and electric screwdriver
- Ideally suited for fittings in trade and industry
- Nickel plated
- Special steel

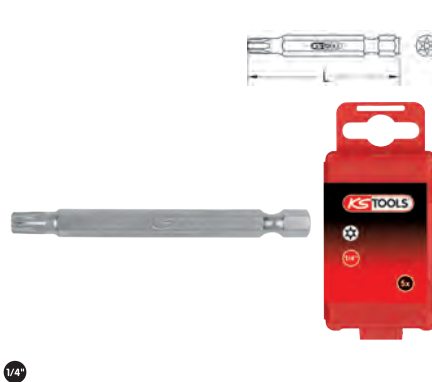

1/4"

		L mm	Content	
911.7501	TB8	75.0	1	20
911.7701	TB8	75.0	5	110
911.7502	TB10	75.0	1	20
911.7702	TB10	75.0	5	110
911.7503	TB15	75.0	1	20
911.7703	TB15	75.0	5	110
911.7504	TB20	75.0	1	20
911.7704	TB20	75.0	5	110
911.7505	TB25	75.0	1	20
911.7705	TB25	75.0	5	110
911.7506	TB27	75.0	1	20
911.7706	TB27	75.0	5	110
911.7507	TB30	75.0	1	25
911.7707	TB30	75.0	5	140
911.7508	TB35	75.0	1	25
911.7708	TB35	75.0	5	140
911.7509	TB40	75.0	1	25
911.7709	TB40	75.0	5	140

CLASSIC bit for hexagon tamperproof screws

- Tamperproof hexagon
- External hexagon drive to DIN 3126 / ISO 1173 - E 6,3
- Can be used by hand or with and electric screwdriver
- Ideally suited for fittings in trade and industry
- Nickel plated
- Special steel



1/4"

	mm	L mm	Content	
911.7510	2,0	75.0	1	20
911.7710	2,0	75.0	5	110
911.7511	2,5	75.0	1	20
911.7711	2,5	75.0	5	110
911.7512	3,0	75.0	1	20
911.7712	3,0	75.0	5	110
911.7513	4,0	75.0	1	20
911.7713	4,0	75.0	5	110
911.7514	5,0	75.0	1	20
911.7714	5,0	75.0	5	110
911.7515	6,0	75.0	1	20
911.7715	6,0	75.0	5	110

CLASSIC bit for security screws

- Security
- External hexagon drive to DIN 3126 / ISO 1173 - E 6,3
- Can be used by hand or with and electric screwdriver
- Ideally suited for fittings in trade and industry
- Nickel plated
- Special steel

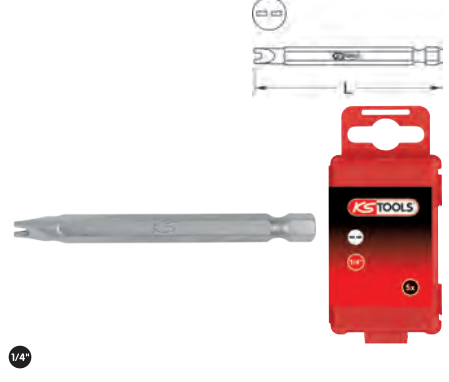

1/4"

	mm	L mm	Content	
911.7523	4.0	75.0	1	20
911.7723	4.0	75.0	5	110
911.7524	6.0	75.0	1	20
911.7724	6.0	75.0	5	110
911.7525	8.0	75.0	1	25
911.7725	8.0	75.0	5	140
911.7526	10.0	75.0	1	25
911.7726	10.0	75.0	5	140

CLASSIC bit for Torq® screws

- Torq®
- External hexagon drive to DIN 3126 / ISO 1173 - E 6,3
- Can be used by hand or with and electric screwdriver
- Ideally suited for fittings in trade and industry
- Nickel plated
- Special steel

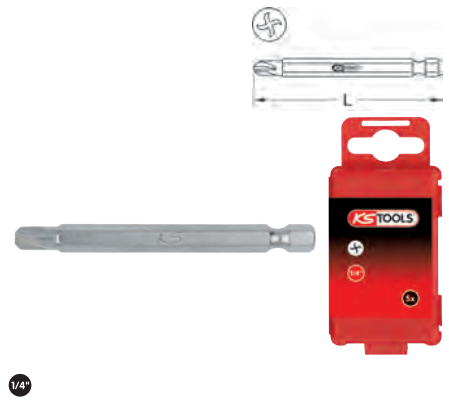

1/4"

	mm	L mm	Content	
911.7516	6.0	75.0	1	20
911.7716	6.0	75.0	5	110
911.7517	8.0	75.0	1	25
911.7717	8.0	75.0	5	140
911.7518	10.0	75.0	1	25
911.7718	10.0	75.0	5	140



CLASSIC bit for TRIWING® screws

- TRIWING®
- External hexagon drive to DIN 3126 / ISO 1173 - E 6,3
- Can be used by hand or with and electric screwdriver
- Ideally suited for fittings in trade and industry
- Nickel plated
- Special steel



1/4"

	mm	L mm	Content	
911.7519	4,0	75,0	1	20
911.7719	4,0	75,0	5	110
911.7520	6,0	75,0	1	20
911.7720	6,0	75,0	5	110
911.7521	8,0	75,0	1	25
911.7721	8,0	75,0	5	140
911.7522	10,0	75,0	1	25
911.7722	10,0	75,0	5	140

1/4" CLASSIC BIT SETS 75 mm

CLASSIC bit set

- External hexagon drive to DIN 3126 / ISO 1173 - E 6,3
- Can be used by hand or with and electric screwdriver
- Ideally suited for fittings in trade and industry
- Orderly arrangement of the popular 1/4" bits
- Nickel plated
- Special steel
- In durable plastic storage case



1/4"

	mm	L mm	Content	
911.7550	32 pcs		CLASSIC bit set	0.67
4 x			4 - 5 - 6 - 7 mm	
6 x			1 x PH1 - 3 x PH2 - 2 x PH3	
9 x			2 x PZ1 - 4 x PZ2 - 3 x PZ3	
6 x			2 - 2,5 - 3 - 4 - 5 - 6 mm	
7 x			T10 - T15 - T20 - T25 - T27 - T30 - T40	

CLASSIC bit set

- External hexagon drive to DIN 3126 / ISO 1173 - E 6,3
- Can be used by hand or with and electric screwdriver
- Ideally suited for fittings in trade and industry
- Orderly arrangement of the popular 1/4" security bits
- Nickel plated
- Special steel
- In durable plastic storage case



1/4"

	mm	L mm	Content	
911.7532	32 pcs		CLASSIC bit set	0.65
1 x			6 mm	
2 x			PH1 - PH2	
3 x			PZ1 - PZ2 - PZ3	
6 x			2 - 2,5 - 3 - 4 - 5 - 6 mm	
9 x			TB8 - TB10 - TB15 - TB20 - TB25 - TB27 - TB30 - TB35 - TB40	
4 x			#1 - #2 - #3 - #4	
4 x			4 - 6 - 8 - 10 mm	
3 x			6 - 8 - 10 mm	

CLASSIC bit set

- External hexagon drive to DIN 3126 / ISO 1173 - C 6,3
- Can be used by hand or with and electric screwdriver
- Includes quick release bit holder
- Ideally suited for fittings in trade and industry
- Orderly arrangement of the popular 1/4" bits
- Sand blasted
- Special steel
- In durable plastic storage case



1/4"

	mm	L mm	Content	
911.2031	113 pcs		CLASSIC bit set	1.17
1 x			1/4"	
1 x			1/4"	
3 x			PH2	
3 x			PZ2	
7 x			T10 - T15 - 3 x T20 - T25 - T30	

14 x			7 x 4 - 7 x 6 mm
21 x			7 x PH1 - 7 x PH2 - 7 x PH3
21 x			7 x PZ1 - 7 x PZ2 - 7 x PZ3
21 x			7 x 4 - 7 x 5 - 7 x 6 mm
14 x			2 x T10 - 2 x T15 - 2 x T20 - 2 x T25 - 2 x T27 - 2 x T30 - 2 x T40
7 x			T10 - T15 - T20 - T25 - T27 - T30 - T40

CLASSIC bit set

- External hexagon drive to DIN 3126 / ISO 1173 - C 6,3
- Can be used by hand or with and electric screwdriver
- Includes bitholder and 1/4" socket adapter
- Ideally suited for fittings in trade and industry
- Orderly arrangement of the popular 1/4" bits
- Sand blasted
- Special steel
- In durable plastic storage case



1/4"

	mm	L mm	Content	
911.2027	99 pcs		CLASSIC bit set	0.75
1 x			1/4"	
1 x			1/4"	
1 x			1/4"	
9 x			3 - 4 - 4,5 - 5 - 5,5 - 6 - 6,5 - 7 - 8	
5 x			PH0 - PH1 - 2 x PH2 - PH3	
5 x			PZ0 - PZ1 - 2 x PZ2 - PZ3	
9 x			1,5 - 2 - 2,5 - 3 - 4 - 5 - 5,5 - 6 - 8	
6 x			2 - 2,5 - 3 - 4 - 5 - 6	
6 x			5/64" - 3/32" - 7/64" - 1/8" - 9/64" - 5/32"	
9 x			T8 - T10 - T15 - T20 - T25 - T27 - T30 - T40 - T45	
9 x			TB8 - TB10 - TB15 - TB20 - TB25 - TB27 - TB30 - TB35 - TB40	
3 x			M5 - M6 - M8	
3 x			#1 - #2 - #3	
4 x			#1 - #2 - #3 - #4	
4 x			4 - 6 - 8 - 10 mm	
3 x			6 - 8 - 10 mm	
4 x			#0 - #1 - #2 - #3	
3 x			4 - 5 - 6 mm	
3 x			TB15 - TB20 - TB30	
4 x			#1 - #2 - #3 - 4 #	
4 x			4 - 6 - 8 - 10 mm	
3 x			6 - 8 - 10 mm	

1/4" TIN BITS 25 mm

TIN bit for slotted screws

- Slotted
- External hexagon drive to DIN 3126 / ISO 1173 - C 6,3
- Can be used by hand or with an electric screwdriver
- Ideally suited for fittings in trade and industry
- Extreme hard coating
- Especially for constant load during industrial applications
- Titanium nitride coated
- Special steel

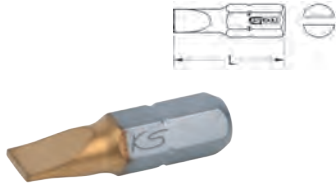

	L mm	Content	
911.2620	4,0	25,0	1 6
911.2621	4,0	25,0	5 40
911.2622	5,5	25,0	1 6
911.2623	5,5	25,0	5 40
911.2632	6,5	25,0	1 8
911.2633	6,5	25,0	5 50
911.2634	8,0	25,0	1 8
911.2635	8,0	25,0	5 50



TIN bit for hexagon screws

- Hexagon socket
- With external hexagon drive to DIN 3126 / ISO 1173 - C 6,3
- Can be used by hand or with an electric screwdriver
- Ideally suited for fittings in trade and industry
- Extreme hard coating
- Especially for constant load during industrial applications
- Titanium nitride coated
- Special steel

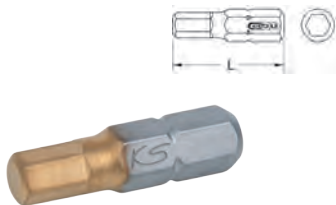

	mm	L mm	Content	
911.3664	2,0	25,0	1 6	
911.3665	2,0	25,0	5 40	
911.3666	2,5	25,0	1 6	
911.3667	2,5	25,0	5 40	
911.3668	3,0	25,0	1 6	
911.3669	3,0	25,0	5 40	
911.3670	4,0	25,0	1 6	
911.3671	4,0	25,0	5 40	
911.3672	5,0	25,0	1 6	
911.3673	5,0	25,0	5 40	
911.3674	6,0	25,0	1 6	
911.3675	6,0	25,0	5 40	
911.3676	8,0	25,0	1 8	
911.3677	8,0	25,0	5 50	
911.3678	10,0	25,0	1 8	
911.3679	10,0	25,0	5 50	



TIN bit for Phillips screws PH

- PH
- With external hexagon drive to DIN 3126 / ISO 1173 - C 6,3
- Can be used by hand or with an electric screwdriver
- Ideally suited for fittings in trade and industry
- Extreme hard coating
- Especially for constant load during industrial applications
- Titanium nitride coated
- Special steel

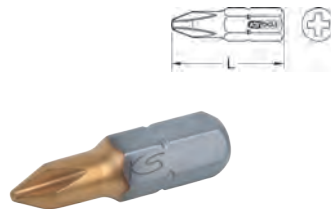

	L mm	Content	
911.2636	PH1	25,0	1 6
911.2637	PH1	25,0	5 40
911.2638	PH2	25,0	1 6
911.2639	PH2	25,0	5 40
911.2640	PH3	25,0	1 6
911.2641	PH3	25,0	5 40

TIN bit for Phillips screws PZ

- PZ
- With external hexagon drive to DIN 3126 / ISO 1173 - C 6,3
- Can be used by hand or with an electric screwdriver
- Ideally suited for fittings in trade and industry
- Extreme hard coating
- Especially for constant load during industrial applications
- Titanium nitride coated
- Special steel

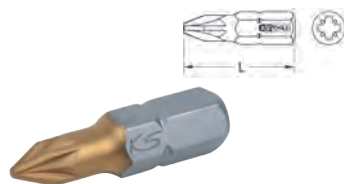

	L mm	Content	
911.2648	PZ1	25,0	1 6
911.2649	PZ1	25,0	5 40
911.2624	PZ2	25,0	1 6
911.2625	PZ2	25,0	5 40
911.2626	PZ3	25,0	1 6
911.2627	PZ3	25,0	5 40

TIN bit for TX screws

- TX
- With external hexagon drive to DIN 3126 / ISO 1173 - C 6,3
- Can be used by hand or with an electric screwdriver
- Ideally suited for fittings in trade and industry
- Extreme hard coating
- Especially for constant load during industrial applications
- Titanium nitride coated
- Special steel

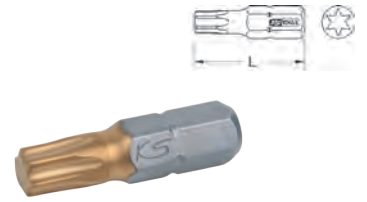

	L mm	Content	
911.3650	T10	25,0	1 6
911.3651	T10	25,0	5 40
911.3652	T15	25,0	1 6
911.3653	T15	25,0	5 40
911.3654	T20	25,0	1 6
911.3655	T20	25,0	5 40
911.3656	T25	25,0	1 6
911.3657	T25	25,0	5 40
911.3658	T27	25,0	1 6
911.3659	T27	25,0	5 40
911.3660	T30	25,0	1 8
911.3661	T30	25,0	5 50
911.3662	T40	25,0	1 8
911.3663	T40	25,0	5 50



1/4" TIN BITS 50 mm

TIN bit for phillips screws PH

- PH
- External hexagon drive to DIN 3126 / ISO 1173 form C 8
- Can be used by hand, electric screwdriver and impact drivers
- Ideally suited for fittings in trade and industry
- Extreme hard coating
- Especially for constant load during industrial applications
- Titanium nitride coated
- Special steel



	L mm	Content	
911.2642	PH1	50,0	1 10
911.2643	PH1	50,0	5 60
911.2644	PH2	50,0	1 10
911.2645	PH2	50,0	5 60
911.2646	PH3	50,0	1 10
911.2647	PH3	50,0	5 60

TIN bit for phillips screws PZ

- PZ
- External hexagon drive to DIN 3126 / ISO 1173 - E 6,3
- Can be used by hand or with and electric screwdriver
- Ideally suited for fittings in trade and industry
- Extreme hard coating
- Especially for constant load during industrial applications
- Titanium nitride coated
- Special steel



		L mm	Content	
911.3641	PZ1	50.0	1	10
911.3642	PZ1	50.0	5	60
911.3643	PZ2	50.0	1	10
911.3644	PZ2	50.0	5	60
911.3645	PZ3	50.0	1	10
911.3646	PZ3	50.0	5	60



1/4" TORSIONpower BITS 25 mm

TORSIONpower bit for slotted screws

- Slotted
- External hexagon drive to DIN 3126 / ISO 1173 - C 6,3
- Can be used by hand or with and electric screwdriver
- Colour coding
- Ideally suited for fittings in trade and industry
- With torsion zone
- To cushion high level torque
- Longer service life
- Nickel plated
- Special steel

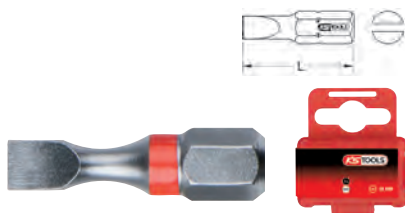

		mm	L mm	Content	
918.3305		3.0	25.0	1	6
918.3306		3.0	25.0	5	40
918.3310		4.0	25.0	1	6
918.3311		4.0	25.0	5	40
918.3315		5.0	25.0	1	6
918.3316		5.0	25.0	5	40
918.3320		6.0	25.0	1	6
918.3321		6.0	25.0	5	40

TORSIONpower bit for hexagon screws

- Hexagon socket
- External hexagon drive to DIN 3126 / ISO 1173 - C 6,3
- Can be used by hand or with and electric screwdriver
- Colour coding
- Ideally suited for fittings in trade and industry
- With torsion zone
- To cushion high level torque
- Longer service life
- Nickel plated
- Special steel

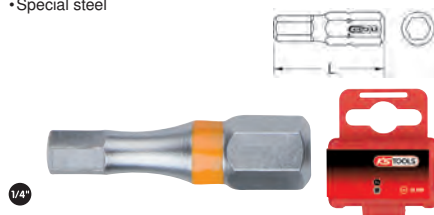

		mm	L mm	Content	
918.3405		3	25.0	1	10
918.3406		3	25.0	5	40
918.3410		4	25.0	1	6
918.3411		4	25.0	5	40
918.3415		5	25.0	1	6
918.3416		5	25.0	5	40
918.3420		6	25.0	1	6
918.3421		6	25.0	5	40

TORSIONpower bit for phillips screws PH

- PH
- External hexagon drive to DIN 3126 / ISO 1173 - C 6,3
- Can be used by hand or with and electric screwdriver
- Colour coding
- Ideally suited for fittings in trade and industry
- With torsion zone
- To cushion high level torque
- Longer service life
- Nickel plated
- Special steel

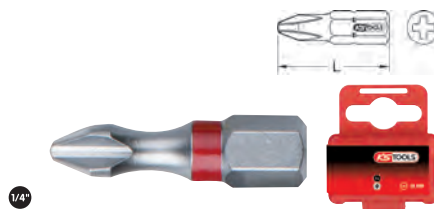

		L mm	Content	
918.3105	PH1	25.0	1	6
918.3106	PH1	25.0	5	40
918.3110	PH2	25.0	1	6
918.3111	PH2	25.0	5	40
918.3115	PH3	25.0	1	6
918.3116	PH3	25.0	5	40

TORSIONpower bit for phillips screws PZ

- PZ
- External hexagon drive to DIN 3126 / ISO 1173 - C 6,3
- Can be used by hand or with and electric screwdriver
- Colour coding
- Ideally suited for fittings in trade and industry
- With torsion zone
- To cushion high level torque
- Longer service life
- Nickel plated
- Special steel

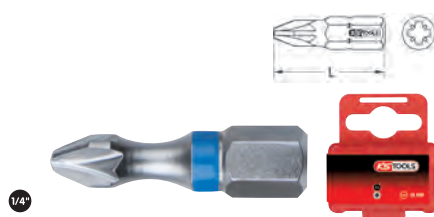

		L mm	Content	
918.3205	PZ1	25.0	1	6
918.3206	PZ1	25.0	5	40
918.3210	PZ2	25.0	1	6
918.3211	PZ2	25.0	5	40
918.3215	PZ3	25.0	1	6
918.3216	PZ3	25.0	5	40

TORSIONpower bit for TX screws

- TX
- External hexagon drive to DIN 3126 / ISO 1173 - C 6,3
- Can be used by hand or with and electric screwdriver
- Colour coding
- Ideally suited for fittings in trade and industry
- With torsion zone
- To cushion high level torque
- Longer service life
- Nickel plated
- Special steel

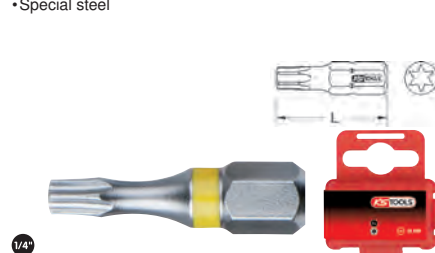

		L mm	Content	
918.3505	T10	25.0	1	6
918.3506	T10	25.0	5	40
918.3510	T15	25.0	1	6
918.3511	T15	25.0	5	40
918.3515	T20	25.0	1	6
918.3516	T20	25.0	5	40
918.3520	T25	25.0	1	6
918.3521	T25	25.0	5	40
918.3525	T27	25.0	1	6
918.3526	T27	25.0	5	40
918.3530	T30	25.0	1	8
918.3531	T30	25.0	5	50
918.3535	T40	25.0	1	8
918.3536	T40	25.0	5	50

TORSIONpower bit for TX tamperproof screws

- For tamperproof TX
- External hexagon drive to DIN 3126 / ISO 1173 - C 6,3
- Can be used by hand or with and electric screwdriver
- Tamperproof
- Colour coding
- Ideally suited for fittings in trade and industry
- With torsion zone
- To cushion high level torque
- Longer service life
- Nickel plated
- Special steel

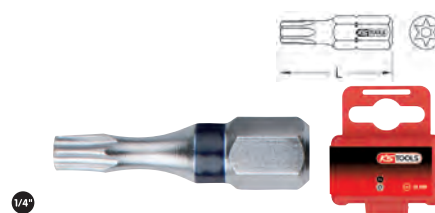

		L mm	Content	
918.3605	TB10	25.0	1	6
918.3606	TB10	25.0	5	40
918.3610	TB15	25.0	1	6
918.3611	TB15	25.0	5	40
918.3615	TB20	25.0	1	6
918.3616	TB20	25.0	5	40
918.3620	TB25	25.0	1	6
918.3621	TB25	25.0	5	40
918.3625	TB27	25.0	1	6
918.3626	TB27	25.0	5	40
918.3630	TB30	25.0	1	8
918.3631	TB30	25.0	5	50
918.3635	TB40	25.0	1	8
918.3636	TB40	25.0	5	50



1/4" TORSIONpower BITS 75 mm

TORSIONpower bit for slotted screws

- Slotted
- External hexagon drive to DIN 3126 / ISO 1173 - C 6,3
- Can be used by hand or with and electric screwdriver
- Colour coding
- Ideally suited for fittings in trade and industry
- With torsion zone
- To cushion high level torque
- Longer service life
- Nickel plated
- Special steel

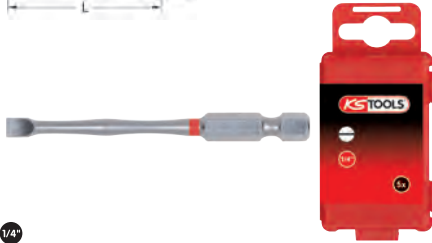

1/4"

	mm	L mm	Content	
918.3350	3.0	75.0	1	20
918.3351	3.0	75.0	5	110
918.3355	4.0	75.0	1	20
918.3356	4.0	75.0	5	110
918.3360	5.0	75.0	1	20
918.3361	5.0	75.0	5	110
918.3365	6.0	75.0	1	20
918.3366	6.0	75.0	5	110

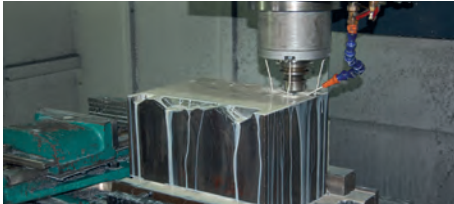

TORSIONpower bit for hexagon screws

- Hexagon socket
- External hexagon drive to DIN 3126 / ISO 1173 - C 6,3
- Can be used by hand or with and electric screwdriver
- Colour coding
- Ideally suited for fittings in trade and industry
- With torsion zone
- To cushion high level torque
- Longer service life
- Nickel plated
- Special steel

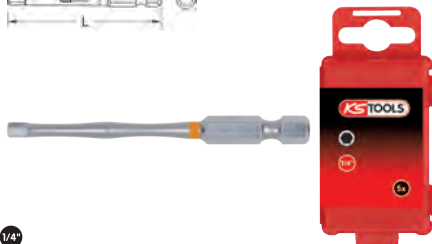

1/4"

	mm	L mm	Content	
918.3450	3	75.0	1	20
918.3451	3	75.0	5	110
918.3455	4	75.0	1	20
918.3456	4	75.0	5	110
918.3460	5	75.0	1	20
918.3461	5	75.0	5	110
918.3465	6	75.0	1	20
918.3466	6	75.0	5	110



TORSIONpower bit for phillips screws PH

- PH
- External hexagon drive to DIN 3126 / ISO 1173 - C 6,3
- Can be used by hand or with and electric screwdriver
- Colour coding
- Ideally suited for fittings in trade and industry
- With torsion zone
- To cushion high level torque
- Longer service life
- Nickel plated
- Special steel

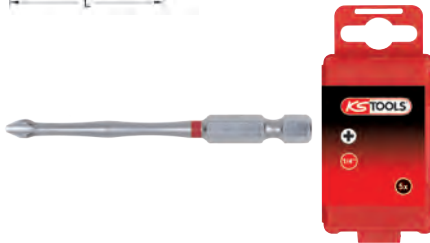

1/4"

		L mm	Content	
918.3150	PH1	75.0	1	20
918.3151	PH1	75.0	5	110
918.3155	PH2	75.0	1	20
918.3156	PH2	75.0	5	110
918.3160	PH3	75.0	1	20
918.3161	PH3	75.0	5	110

TORSIONpower bit for phillips screws PZ

- PZ
- External hexagon drive to DIN 3126 / ISO 1173 - C 6,3
- Can be used by hand or with and electric screwdriver
- Colour coding
- Ideally suited for fittings in trade and industry
- With torsion zone
- To cushion high level torque
- Longer service life
- Nickel plated
- Special steel



1/4"

		L mm	Content	
918.3250	PZ1	75.0	1	20
918.3251	PZ1	75.0	5	110
918.3255	PZ2	75.0	1	20
918.3256	PZ2	75.0	5	110
918.3260	PZ3	75.0	1	20
918.3261	PZ3	75.0	5	110

TORSIONpower bit for TX screws

- TX
- External hexagon drive to DIN 3126 / ISO 1173 - C 6,3
- Can be used by hand or with and electric screwdriver
- Colour coding
- Ideally suited for fittings in trade and industry
- With torsion zone
- To cushion high level torque
- Longer service life
- Nickel plated
- Special steel

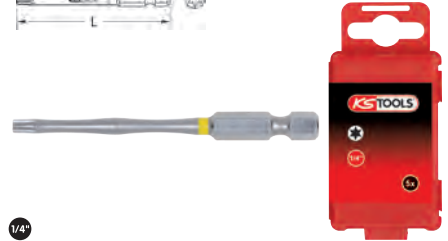

1/4"

		L mm	Content	
918.3550	T10	75.0	1	20
918.3551	T10	75.0	5	110
918.3555	T15	75.0	1	20
918.3556	T15	75.0	5	110
918.3560	T20	75.0	1	20
918.3561	T20	75.0	5	110
918.3565	T25	75.0	1	20
918.3566	T25	75.0	5	110
918.3570	T27	75.0	1	20
918.3571	T27	75.0	5	110
918.3575	T30	75.0	1	25
918.3576	T30	75.0	5	140
918.3580	T40	75.0	1	25
918.3581	T40	75.0	5	140

TORSIONpower bit for TX tamperproof screws

- For tamperproof TX
- External hexagon drive to DIN 3126 / ISO 1173 - C 6,3
- Can be used by hand or with and electric screwdriver
- Tamperproof
- Colour coding
- Ideally suited for fittings in trade and industry
- With torsion zone
- To cushion high level torque
- Longer service life
- Nickel plated
- Special steel

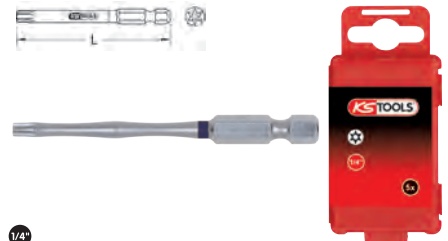

1/4"

		L mm	Content	
918.3650	TB10	75.0	1	20
918.3651	TB10	75.0	5	110
918.3655	TB15	75.0	1	20
918.3656	TB15	75.0	5	110
918.3660	TB20	75.0	1	20
918.3661	TB20	75.0	5	110
918.3665	TB25	75.0	1	20
918.3666	TB25	75.0	5	110
918.3670	TB27	75.0	1	20
918.3671	TB27	75.0	5	110
918.3675	TB30	75.0	1	25
918.3676	TB30	75.0	5	140
918.3680	TB40	75.0	1	25
918.3681	TB40	75.0	5	140

1/4" TORSIONpower BIT SETS

TORSIONpower Bit-Box

- External hexagon drive to DIN 3126 / ISO 1173 - C 6,3
- Can be used by hand or with and electric screwdriver
- Colour coding
- Includes magnetic quick release bit holder and 1/4" socket adaptor
- Ideally suited for fittings in trade and industry
- Practical belt holder
- Precise and orderly arrangement of the popular 1/4" bits
- Nickel plated
- Special steel
- Includes durable two component storage case



1/4"

		1		10	
		Content		g	
918.3010	32 pcs	TORSIONpower Bit-Box		360	
1 x		1/4"			
1 x		1/4"			
4 x		3 - 4 - 5 - 6 mm			
4 x		1 x PH1 - 2 x PH2 - 1 x PH3			
4 x		1 x PZ1 - 2 x PZ2 - 1 x PZ3			
4 x		3 - 4 - 5 - 6 mm			
7 x		T10 - T15 - T20 - T25 - T27 - T30 - T40			
7 x		TB10 - TB15 - TB20 - TB25 - TB27 - TB30 - TB40			

5/16" CLASSIC BITS

CLASSIC bit for slotted screws

- Slotted
- External hexagon drive to DIN 3126 / ISO 1173 form C 8
- Can be used by hand, electric screwdriver and impact drivers
- Ideally suited for fittings in trade and industry
- Reinforced execution
- Nickel plated
- Special steel



5/16"

		L		Content		g	
		mm		mm		g	
911.3680	5.5	30.0		1		10	
911.3681	6.5	30.0		1		10	
911.3682	7.0	30.0		1		10	
911.5141	8.0	30.0		1		10	
911.3683	9.0	30.0		1		10	
911.5142	10.0	30.0		1		10	
911.5143	12.0	30.0		1		10	
911.3684	14.0	30.0		1		10	
911.3685	16.0	30.0		1		10	
911.3686	18.0	30.0		1		10	
911.3687	20.0	30.0		1		10	

CLASSIC bit for phillips screws PH

- PH
- External hexagon drive to DIN 3126 / ISO 1173 form C 8
- Can be used by hand, electric screwdriver and impact drivers
- Ideally suited for fittings in trade and industry
- Reinforced execution
- Nickel plated
- Special steel



5/16"

		L		Content		g	
		mm		mm		g	
911.5132	PH1	30.0		1		10	
911.5133	PH2	30.0		1		10	
911.5134	PH3	30.0		1		10	
911.5135	PH4	30.0		1		10	

CLASSIC bit for phillips screws PZ

- PZ
- External hexagon drive to DIN 3126 / ISO 1173 form C 8
- Can be used by hand, electric screwdriver and impact drivers
- Ideally suited for fittings in trade and industry
- Reinforced execution
- Nickel plated
- Special steel



5/16"

		L		Content		g	
		mm		mm		g	
911.5121	PZ1	30.0		1		10	
911.5122	PZ2	30.0		1		10	
911.5123	PZ3	30.0		1		10	
911.5124	PZ4	30.0		1		10	

CLASSIC bit for hexagon screws

- Hexagon socket
- External hexagon drive to DIN 3126 / ISO 1173 form C 8
- Can be used by hand, electric screwdriver and impact drivers
- Ideally suited for fittings in trade and industry
- Reinforced execution
- Nickel plated
- Special steel



5/16"

		L		Content		g	
		mm		mm		g	
911.3695	5,0	30.0		1		10	
911.3696	4,0	30.0		1		10	
911.3697	3,0	30.0		1		10	
911.5126	6,0	30.0		1		10	
911.5127	7,0	30.0		1		10	
911.5128	8,0	30.0		1		10	
911.5129	10,0	30.0		1		10	
911.5130	12,0	30.0		1		10	
911.5131	14,0	30.0		1		10	

CLASSIC bit for spline screws

- Spline
- External hexagon drive to DIN 3126 / ISO 1173 form C 8
- Can be used by hand, electric screwdriver and impact drivers
- Ideally suited for fittings in trade and industry
- Reinforced execution
- Nickel plated
- Special steel



5/16"

		L		Content		g	
		mm		mm		g	
911.5154	M4	30.0		1		10	
911.5155	M5	30.0		1		10	
911.5156	M6	30.0		1		10	
911.5157	M8	30.0		1		10	
911.5158	M10	30.0		1		10	
911.5159	M12	30.0		1		10	
911.3698	M14	30.0		1		10	

CLASSIC bit for TX screws

- TX
- External hexagon drive to DIN 3126 / ISO 1173 form C 8
- Can be used by hand, electric screwdriver and impact drivers
- Ideally suited for fittings in trade and industry
- Reinforced execution
- Nickel plated
- Special steela



5/16"

		L		Content		g	
		mm		mm		g	
911.3688	T20	30.0		1		10	
911.3689	T25	30.0		1		10	
911.3690	T27	30.0		1		10	
911.3691	T30	30.0		1		10	
911.5144	T40	30.0		1		10	
911.5145	T45	30.0		1		10	
911.5146	T50	30.0		1		10	
911.5147	T55	30.0		1		10	
911.5148	T60	30.0		1		10	
911.5149	T70	30.0		1		15	

CLASSIC bit for TX tamperproof screws

- For tamperproof TX
- External hexagon drive to DIN 3126 / ISO 1173 form C 8
- Can be used by hand, electric screwdriver and impact drivers
- Ideally suited for fittings in trade and industry
- Reinforced execution
- Nickel plated
- Special steel



5/16"

		L		Content		g	
		mm		mm		g	
911.3692	TB25	30.0		1		10	
911.3693	TB27	30.0		1		10	
911.3694	TB30	30.0		1		10	
911.5136	TB40	30.0		1		10	
911.5137	TB45	30.0		1		10	
911.5138	TB50	30.0		1		10	
911.5139	TB55	30.0		1		10	
911.5140	TB60	30.0		1		10	
911.5152	TB70	30.0		1		15	

CLASSIC bit for RIBE® screws

- RIBE®
- External hexagon drive to DIN 3126 / ISO 1173 form C 8
- Can be used by hand, electric screwdriver and impact drivers
- Ideally suited for fittings in trade and industry
- Reinforced execution
- Phosphate finish
- Special steel



		L mm	Content	
911.3699	M4	38.0	1	10
911.5165	M5	38.0	1	10
911.5166	M6	38.0	1	10
911.5167	M7	38.0	1	10
911.5168	M8	38.0	1	20
911.5169	M10	38.0	1	20
911.5170	M12	38.0	1	30
911.3754	M14	38.0	1	30

CLASSIC bit for RIBE® screws

- RIBE®
- External hexagon drive to DIN 3126 / ISO 1173 form C 8
- Can be used by hand, electric screwdriver and impact drivers
- Ideally suited for fittings in trade and industry
- Reinforced execution
- Phosphate finish
- Special steel



		L mm	Content	
911.5171	M7	100.0	1	40
911.5172	M8	100.0	1	50
911.5173	M9	100.0	1	60
911.5174	M10	100.0	1	70
911.5175	M12	100.0	1	80
911.5176	M13	100.0	1	90
911.5177	M14	100.0	1	100

5/16" CLASSIC BIT SETS

CLASSIC Bit set

- Ideal set compilation for RIBE® screws
- External hexagon drive to DIN 3126 / ISO 1173 form C 8
- Can be used by hand, electric screwdriver and impact drivers
- Ideally suited for fittings in trade and industry
- Reinforced execution
- Precise arrangement of the popular 5/16" RIBE® bits
- Phosphate finish
- Special steel
- In durable plastic storage case



		L mm	Content	
911.4306	14 pcs CLASSIC Bit set		0.82	
1 x		1/2"		
6 x	M5 - M6 - M7 - M8 - M10 - M12			
7 x	M7 - M8 - M9 - M10 - M12 - M13 - M14			

10 mm CLASSIC BITS 30 mm

CLASSIC bit for slotted screws

- Slotted
- 10 mm external hexagon
- Can be used by hand, electric screwdriver and impact drivers
- Ideally suited for fittings in trade and industry
- Reinforced execution
- Sand-blasted
- Special steel



	mm	L mm	Content	
930.3015	8.0	30.0	1	40
930.3016	10.0	30.0	1	40

CLASSIC bit for phillips screws PH

- PH
- 10 mm external hexagon
- Can be used by hand, electric screwdriver and impact drivers
- Ideally suited for fittings in trade and industry
- Reinforced execution
- Sand-blasted
- Special steel



		L mm	Content	
930.3019	PH1	30.0	1	40
930.3017	PH2	30.0	1	40
930.3018	PH3	30.0	1	40

CLASSIC bit for phillips screws PZ

- PZ
- 10 mm external hexagon
- Can be used by hand, electric screwdriver and impact drivers
- Ideally suited for fittings in trade and industry
- Reinforced execution
- Sand-blasted
- Special steel

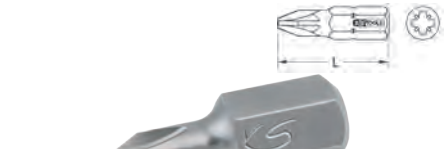

		L mm	Content	
930.3020	PZ1	30.0	1	40
930.3021	PZ2	30.0	1	40
930.3022	PZ3	30.0	1	40

CLASSIC bit for hexagon screws

- Hexagon socket
- 10 mm external hexagon
- Can be used by hand, electric screwdriver and impact drivers
- Ideally suited for fittings in trade and industry
- Reinforced execution
- Sand-blasted
- Special steel



	mm	L mm	Content	
930.1004	4,0	30,0	1	40
930.1005	5,0	30,0	1	40

	mm	L mm	Content	
930.1006	6,0	30,0	1	40
930.1007	7,0	30,0	1	40
930.1008	8,0	30,0	1	40
930.1010	10,0	30,0	1	40
930.1012	12,0	30,0	1	40

CLASSIC bit for spline screws

- Spline
- 10 mm external hexagon
- Can be used by hand, electric screwdriver and impact drivers
- Ideally suited for fittings in trade and industry
- Reinforced execution
- Sand-blasted
- Special steel



		L mm	Content	
930.3005	M5	30.0	1	40
930.3006	M6	30.0	1	40
930.3008	M8	30.0	1	40
930.3010	M10	30.0	1	40
930.3012	M12	30.0	1	40

CLASSIC bit for TX screws

- TX
- 10 mm external hexagon
- Can be used by hand, electric screwdriver and impact drivers
- Ideally suited for fittings in trade and industry
- Reinforced execution
- Sand-blasted
- Special steel



		L mm	Content	
930.2010	T10	30.0	1	40
930.2015	T15	30.0	1	40
930.2020	T20	30.0	1	40
930.2025	T25	30.0	1	40
930.2027	T27	30.0	1	40
930.2030	T30	30.0	1	40
930.2040	T40	30.0	1	40
930.2045	T45	30.0	1	40
930.2050	T50	30.0	1	40
930.2055	T55	30.0	1	40
930.2060	T60	30.0	1	40

CLASSIC bit for TX PLUS screws

- TX PLUS
- With external hexagon drive to DIN 3126 / ISO 1173 Form C 8
- Can be used by hand or with an electric screwdriver
- Ideally suited for fittings in trade and industry
- Reinforced execution
- Sand-blasted
- Special steel



		L mm	Content	
911.3260	IP 40	30.0	1	13
911.3261	IP 45	30.0	1	14
911.3262	IP 50	30.0	1	16
911.3263	IP 55	30.0	1	20
911.3264	IP 60	30.0	1	25

CLASSIC bit for TX tamperproof screws

- For tamperproof TX
- 10 mm external hexagon
- Can be used by hand, electric screwdriver and impact drivers
- Ideally suited for fittings in trade and industry
- Reinforced execution
- Sand-blasted
- Special steel



		L mm	Content	g
930.2110	TB10	30.0	1	40
930.2115	TB15	30.0	1	40
930.2120	TB20	30.0	1	40
930.2125	TB25	30.0	1	40
930.2127	TB27	30.0	1	40
930.2130	TB30	30.0	1	40
930.2140	TB40	30.0	1	40
930.2145	TB45	30.0	1	40
930.2150	TB50	30.0	1	40
930.2155	TB55	30.0	1	40
930.2160	TB60	30.0	1	40

CLASSIC bit for tamper proof five star bits

- Five star bit, tamperproof
- With 10 mm external hexagon
- Can be used by hand, electric screwdriver and impact drivers
- Ideally suited for fittings in trade and industry
- Reinforced execution
- Sand-blasted
- Special steel



		L mm	Content	g
911.3121	TS40	30.0	1	40
911.3122	TS45	30.0	1	40
911.3123	TS50	30.0	1	40
911.3124	TS55	30.0	1	40
911.3125	TS60	30.0	1	40

10 mm CLASSIC BITS 75 mm

CLASSIC bit for hexagon screws

- Hexagon socket
- 10 mm external hexagon
- Can be used by hand, electric screwdriver and impact drivers
- Ideally suited for fittings in trade and industry
- Reinforced execution
- Sand-blasted
- Special steel



mm	L mm	Content	g
975.1004	4,0	75.0	1 70
975.1005	5,0	75.0	1 70
975.1006	6,0	75.0	1 70
975.1007	7,0	75.0	1 70
975.1008	8,0	75.0	1 70
975.1010	10,0	75.0	1 70
975.1012	12,0	75.0	1 70

CLASSIC bit for spline screws

- Spline
- 10 mm external hexagon
- Can be used by hand, electric screwdriver and impact drivers
- Ideally suited for fittings in trade and industry
- Reinforced execution
- Sand-blasted
- Special steel



		L mm	Content	g
975.3005	M5	75.0	1	70
975.3006	M6	75.0	1	70
975.3008	M8	75.0	1	70
975.3010	M10	75.0	1	70
975.3012	M12	75.0	1	70

CLASSIC bit for TX screws

- TX
- 10 mm external hexagon
- Can be used by hand, electric screwdriver and impact drivers
- Ideally suited for fittings in trade and industry
- Reinforced execution
- Sand-blasted
- Special steel



		L mm	Content	g
975.2010	T10	75.0	1	70
975.2015	T15	75.0	1	70
975.2020	T20	75.0	1	70
975.2025	T25	75.0	1	70
975.2027	T27	75.0	1	70
975.2030	T30	75.0	1	70
975.2040	T40	75.0	1	70
975.2045	T45	75.0	1	70
975.2050	T50	75.0	1	70
975.2055	T55	75.0	1	70
975.2060	T60	75.0	1	70
975.2075	T70	75.0	1	70

CLASSIC bit for TX tamperproof screws

- For tamperproof TX
- 10 mm external hexagon
- Can be used by hand, electric screwdriver and impact drivers
- Ideally suited for fittings in trade and industry
- Reinforced execution
- Sand-blasted
- Special steel

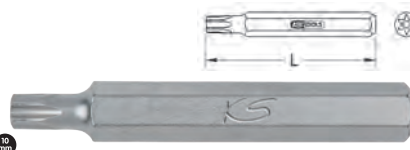

		L mm	Content	g
975.2110	TB10	75.0	1	70
975.2115	TB15	75.0	1	70
975.2120	TB20	75.0	1	70
975.2125	TB25	75.0	1	70
975.2127	TB27	75.0	1	70
975.2130	TB30	75.0	1	70
975.2140	TB40	75.0	1	70
975.2145	TB45	75.0	1	70
975.2150	TB50	75.0	1	70
975.2155	TB55	75.0	1	70
975.2160	TB60	75.0	1	70

10 mm CLASSIC BITS 120 mm

CLASSIC bit for TX screws

- TX
- 10 mm external hexagon
- Can be used by hand, electric screwdriver and impact drivers
- Ideally suited for fittings in trade and industry
- Reinforced execution
- Sand-blasted
- Special steel



		L mm	Content	g
975.4040	T40	120.0	1	80
975.4045	T45	120.0	1	80
975.4050	T50	120.0	1	80
975.4055	T55	120.0	1	80

10 mm CLASSIC BIT SETS

CLASSIC bit set

- Ideal set compilation for TX screws
- 10 mm external hexagon
- Can be used by hand, electric screwdriver and impact drivers
- Includes 1/2" socket adapter for 10 mm bits
- Ideally suited for fittings in trade and industry
- Reinforced execution
- Precise arrangement of the popular 10 mm TX bits
- Sand-blasted
- Special steel
- In durable metal case



		Content	g
911.5020	15 pcs	CLASSIC bit set	0.58
1 x		1/2" x 10 mm	
7 x		T20 - T25 - T30 - T40 - T45 - T50 - T55	
7 x		T20 - T25 - T30 - T40 - T45 - T50 - T55	

CLASSIC bit set

- Ideal set compilation for hexagon socket screws
- 10 mm external hexagon
- Can be used by hand, electric screwdriver and impact drivers
- Includes 1/2" socket adapter for 10 mm bits
- Ideally suited for fittings in trade and industry
- Reinforced execution
- Precise arrangement of the popular 10 mm hexagon socket bits
- Sand-blasted
- Special steel
- In durable metal case



911.5040	15 pcs	CLASSIC bit set	0.58
1 x		1/2" x 10 mm	
7 x		4 - 5 - 6 - 7 - 8 - 10 - 12 mm	
7 x		4 - 5 - 6 - 7 - 8 - 10 - 12 mm	

CLASSIC bit set

- Ideal set for spline screws
- With 10 mm external hexagon
- Can be used by hand, electric screwdriver and impact drivers
- Includes 1/2" socket adapter for 10 mm bits
- Ideally suited for fittings in trade and industry
- Sand-blasted
- Special steel
- In durable plastic storage case



911.5030	11 pcs	CLASSIC bit set	0.60
1 x		1/2" x 10 mm	
5 x		M5 - M6 - M8 - M10 - M12	
5 x		M5 - M6 - M8 - M10 - M12	

CLASSIC bit set

- 10 mm external hexagon
- Can be used by hand, electric screwdriver and impact drivers
- Includes 3/8" + 1/2" socket adapter for 10 mm bits
- Ideally suited for fittings in trade and industry
- Reinforced execution
- Precise arrangement of the popular 10 mm bits
- Sand-blasted
- Special steel
- In durable metal case



911.4304	42 pcs	CLASSIC bit set	1.60
2 x		3/8" - 1/2"	
7 x		4 - 5 - 6 - 7 - 8 - 10 - 12 mm	
8 x		T20 - T25 - T30 - T40 - T45 - T50 - T55 - T60	
5 x		M5 - M6 - M8 - M10 - M12	
2 x		8 - 10 mm	
2 x		PH2 - PH3	
4 x		5 - 6 - 8 - 10 mm	
8 x		T20 - T25 - T30 - T40 - T45 - T50 - T55 - T60	
4 x		M6 - M8 - M10 - M12	



TX Socket and bit set

- Matt finish
- Chrome vanadium
- In durable plastic case

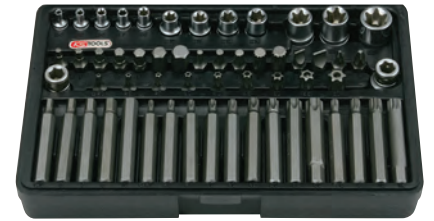

911.4305	57 pcs	TX Socket and bit set	2.00
2 x		3/8" x 10 mm - 1/2" x 1/4"	
12 x		1/4": E4 - E5 - E6 - E7 - E8; 3/8": E10 - E11 - E12 - E14; 1/2": E16 - E18 - E20	
7 x		4 - 5 - 6 - 7 - 8 - 10 - 12 mm	
9 x		TB20 - TB25 - TB27 - TB30 - TB40 - TB45 - TB50 - TB55 - TB60	
5 x		M5 - M6 - M8 - M10 - M12	
2 x		8 - 10 mm	
2 x		PH2 - PH3	
5 x		5 - 6 - 7 - 8 - 10 mm	
9 x		T20 - T25 - T27 - T30 - T40 - T45 - T50 - T55 - T60	
4 x		M6 - M8 - M10 - M12	

CLASSIC bit set

- 10 mm external hexagon
- Can be used by hand, electric screwdriver and impact drivers
- Includes 10 mm reversing ratchet
- Ideally suited for fittings in trade and industry
- Reinforced execution
- Precise arrangement of the popular 10 mm bits and sockets
- Sand-blasted
- Special steel
- In durable ABS storage case



911.4310	37 pcs	CLASSIC bit set	1.60
1 x		10 mm	
6 x		5 - 6 - 7 - 8 - 10 - 12 mm	
8 x		TB20 - TB25 - TB27 - TB30 - TB40 - TB45 - TB50 - TB55	
5 x		M5 - M6 - M8 - M10 - M12	
2 x		PH2 - PH3	
8 x		T20 - T25 - T27 - T30 - T40 - T45 - T50 - T55	
4 x		M6 - M8 - M10 - M12	
3 x		T40 - T45 - T50	



KS TOOLS[®]

Innovation is
our mission!

BITS

**MICRO
CLASSIC**

TORION *power*

TIN Bits

